

вентиляторы SUNON для сервера, хранилищ, телекоммуникаций, шкафов  
продажа в Минске

тел.моб. 8(044)7584780 VEL

8(029)7584780 мтс Минск тел.факс 8(017)2005646

ВЕНТИЛЯТОР SUNON DC продажа в Минске [www.fotorele.net](http://www.fotorele.net) [www.tiristor.by](http://www.tiristor.by)

email [minsk17@tut.by](mailto:minsk17@tut.by)

**SUNON®**

# Server. Storage. Telecom Cooling Solution

\*All products are RoHS compliant.



## Table of Contents

DC Fan		
Size (mm)	Air Flow (CFM)	Page
36X36X28	18.1 ~ 22.8	p.01
38X38X28	11.3 ~ 24.2	p.03
40X40X28	12.8 ~ 31.3	p.09
40X40X56	26.9 ~ 31.7	p.15
60X60X38	54.1 ~ 75.2	p.17
60X60X56	58.5 ~ 72.9	p.21
60X60X76	58.7 ~ 73.2	p.23
80X80X38	113.9 ~ 141.9	p.25
92X92X38	138.1 ~ 182.4	p.29
140X140X38	238.5 ~297.9	p.31
140X140X51	250.3	p.35

DC Blower		
Size (mm)	Air Flow (CFM)	Page
97X95X33	44.2 ~ 54.7	p.37

# 36x36x28 mm

## 18.1~22.8 CFM



■ Specifications

Model	Bearing	Rating Voltage	Power Current	Power Consumption	Speed	Air Flow	Static Pressure	Noise	Weight	Curve
	2BALL Sleeve	(VDC)	(mA)	(WATTS)	(RPM)	(CFM)	(inch-H <sub>2</sub> O)	(dB(A))	(g)	
PF36281BX-0000-A99	☉	12	800	9.60	23000	22.8	2.55	61.9	40.5	1
PF36281B1-0000-A99	☉	12	450	5.40	18400	18.1	1.62	55.7	40.5	2

■ Function

PF36281BX / 1

A99: AutoRestart

F99: AutoRestart and R type

G99: AutoRestart and F type

H99: AutoRestart and PWM

S99: AutoRestart , F type and with PWM

■ Air Flow-Static Pressure Characteristics

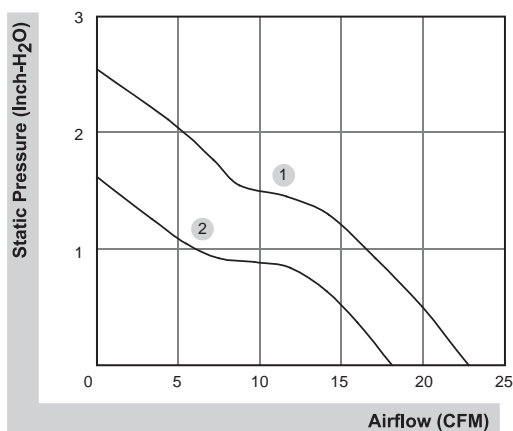

■ External dimensions(mm)

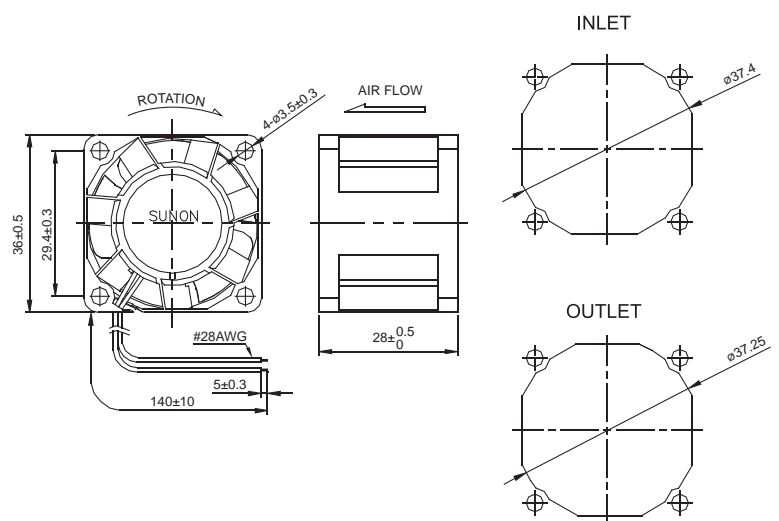

\*All model could be customized. Please contact with Sunon Sales.

\*Specifications are subject to change without notice. Please Visit SUNON website at [www.sunon.com](http://www.sunon.com) for update information.

## RD / FG Signal

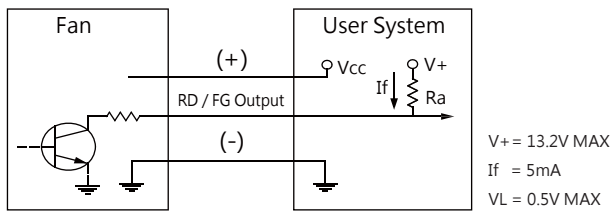

### [ RD Signal ]

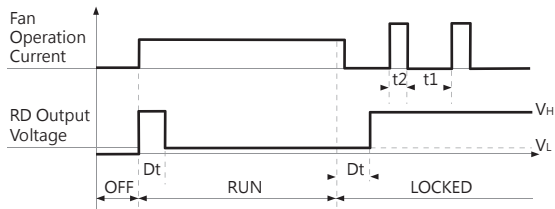

### [ FG Signal ]

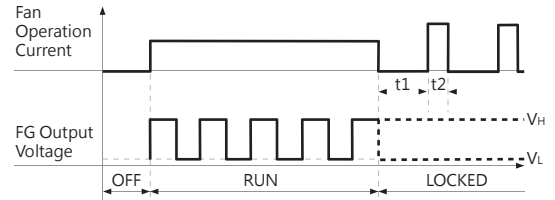
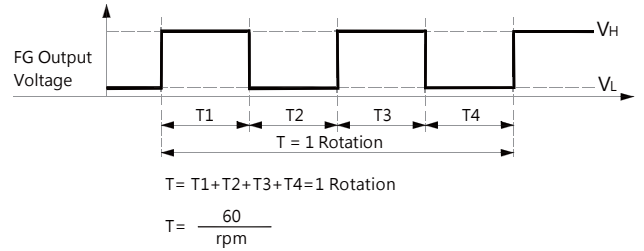

## PWM Input Signal

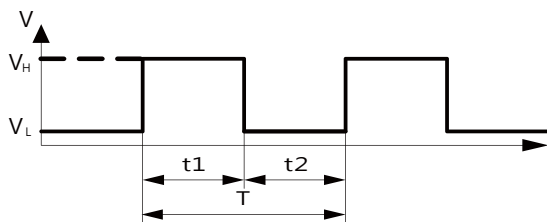
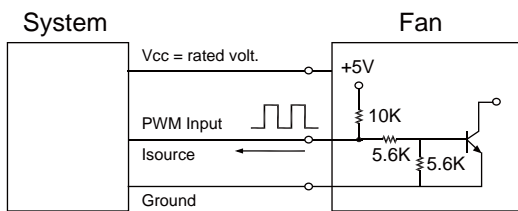

1. Period : 
$$T = \frac{1}{f_{\text{PWM}}} = t1 + t2(\text{sec})$$

2. Duty Cycle ( D.C. ) : 
$$\frac{t1}{t1+t2} * 100 = \frac{t1}{T} * 100(\%)$$

VH=2.3~5.5V

VL=0~0.8V

PWM FREQUENCY: 25KHZ

Isource=0.5mA at PWM Input Voltage 0V

The speed is default to be maximum if PWM input pin is unconnected.

Min. start up duty cycle is 10%.

## PWM Curve

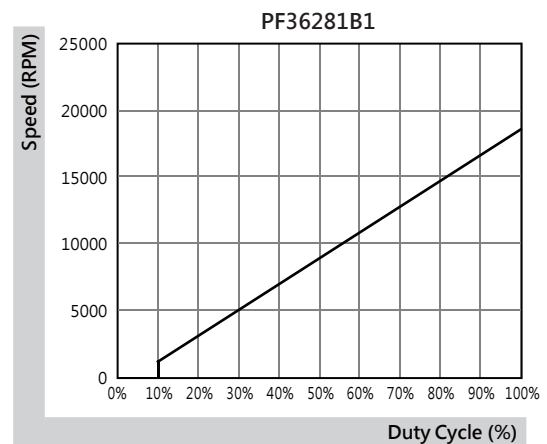
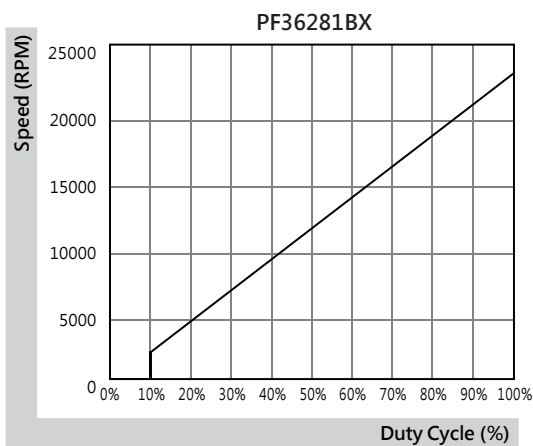

\*All model could be customized. Please contact with Sunon Sales.

\*Specifications are subject to change without notice. Please Visit SUNON website at [www.sunon.com](http://www.sunon.com) for update information.

38x38x28 mm

18.9~24.2 CFM



■ Specifications

Model	Bearing	Rating Voltage	Power Current	Power Consumption	Speed	Air Flow	Static Pressure	Noise	Weight	Curve
	2BALL Sleeve	(VDC)	(mA)	(WATTS)	(RPM)	(CFM)	(inch-H <sub>2</sub> O)	(dB(A))	(g)	
VF38281BX-0000-A9H	☉	12	870	10.44	27000	24.2	4.10	61.6	44.0	1
VF38281B1-0000-A9H	☉	12	475	5.70	21600	18.9	2.50	58.1	44.0	2

■ Function

VF38281BX / 1

A9H: AutoRestart

G9H: AutoRestart and F type

S9H: AutoRestart , F type and PWM

■ Air Flow-Static Pressure Characteristics

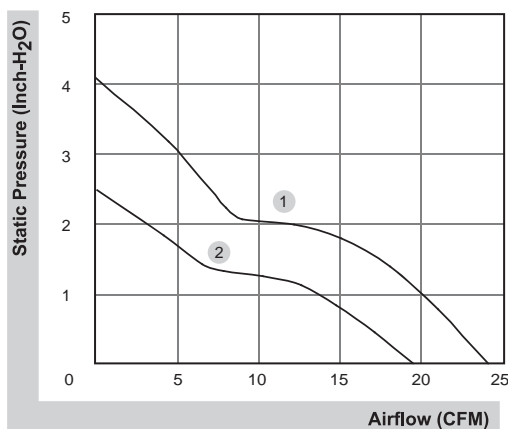

■ External dimensions(mm)

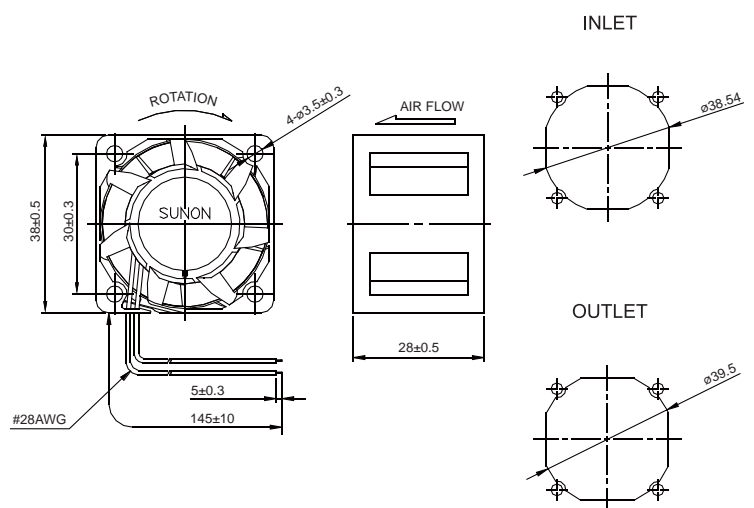

\*All model could be customized. Please contact with Sunon Sales.

\*Specifications are subject to change without notice. Please Visit SUNON website at [www.sunon.com](http://www.sunon.com) for update information.

## RD / FG Signal

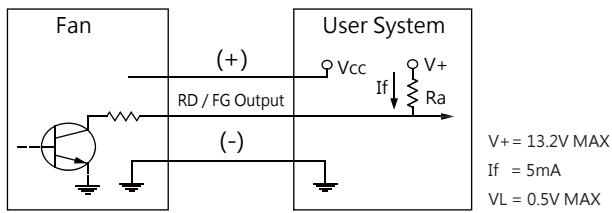

### [ RD Signal ]

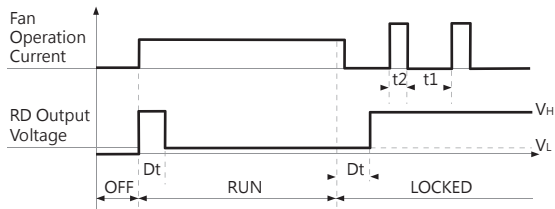

### [ FG Signal ]

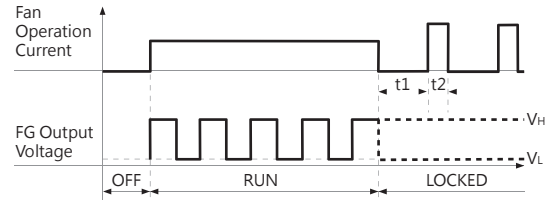
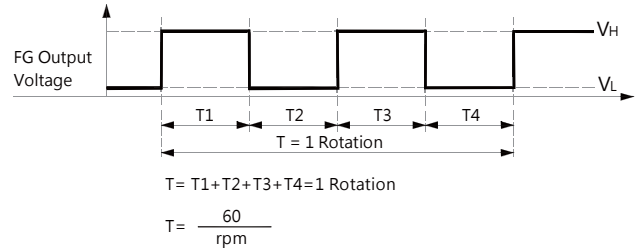

## PWM Input Signal

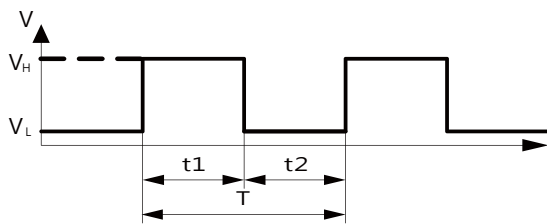
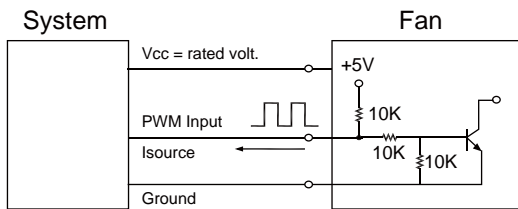

1. Period : 
$$T = \frac{1}{f_{PWM}} = t1 + t2(\text{sec})$$

2. Duty Cycle ( D.C. ) : 
$$\frac{t1}{t1+t2} * 100 = \frac{t1}{T} * 100(\%)$$

VH=2.3~5.5V

VL=0~0.8V

PWM FREQUENCY: 25KHZ

Isource=0.5mA at PWM Input Voltage 0V

The speed is default to be maximum if PWM input pin is unconnected.

Min. start up duty cycle is 10%.

## PWM Curve

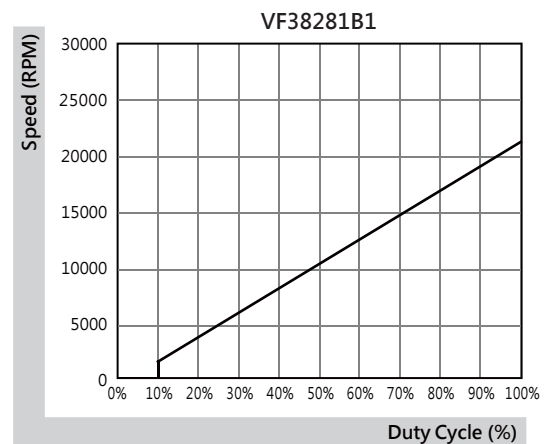
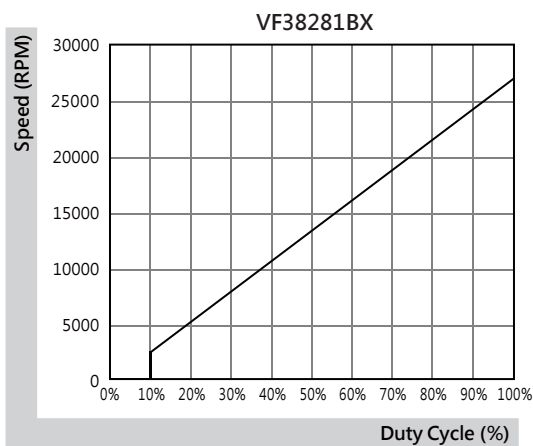

\*All model could be customized. Please contact with Sunon Sales.

\*Specifications are subject to change without notice. Please Visit SUNON website at [www.sunon.com](http://www.sunon.com) for update information.

# 38x38x28 mm

## 18.1 CFM

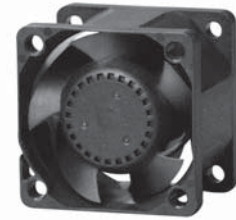

### ■ Specifications

	Bearing	Rating Voltage	Power Current	Power Consumption	Speed	Air Flow	Static Pressure	Noise	Weight	Curve
	● VAPO	(VDC)	(mA)	(WATTS)	(RPM)	(CFM)	(Inch-H <sub>2</sub> O)	(dB(A))	(g)	
PF38281V1-0000-A99	●	12	574	6.89	16000	18.1	1.42	51.8	43.0	1

### ■ Function

PF38281V1

A99: AutoRestart

G99: AutoRestart and F type

S99: AutoRestart , F type and PWM

### ■ Air Flow-Static Pressure Characteristics

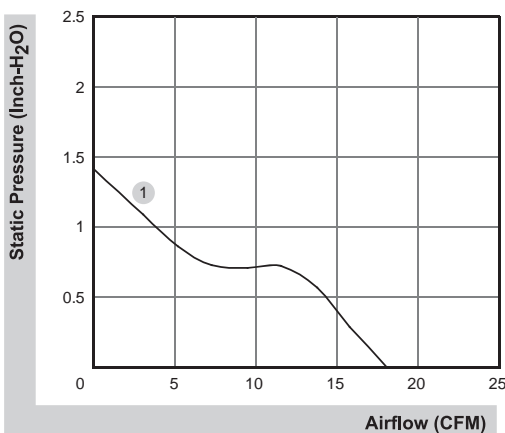

### ■ External dimensions(mm)

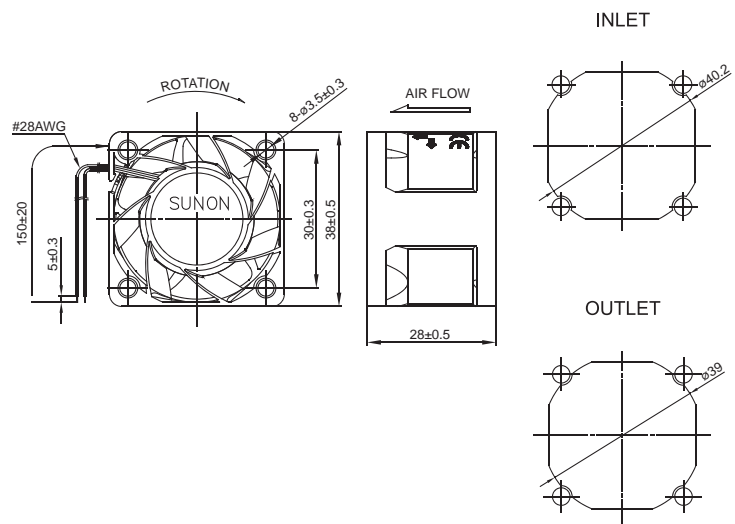

\*All model could be customized. Please contact with Sunon Sales.

\*Specifications are subject to change without notice. Please Visit SUNON website at [www.sunon.com](http://www.sunon.com) for update information.

■ RD / FG Signal

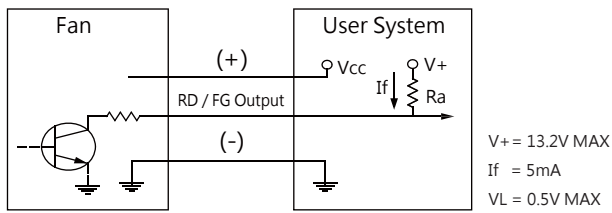

[ RD Signal ]

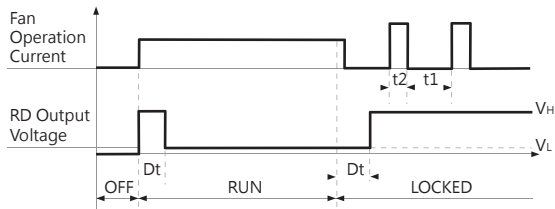

[ FG Signal ]

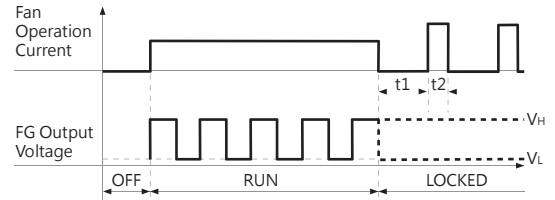
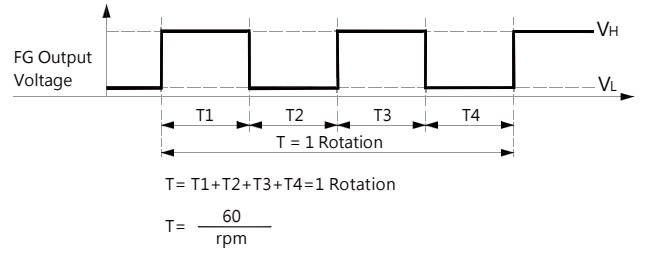

■ PWM Input Signal

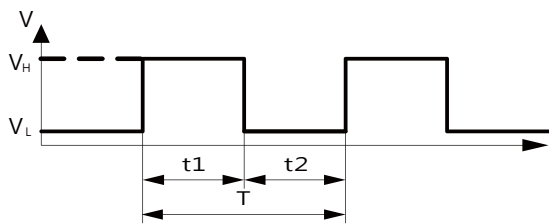
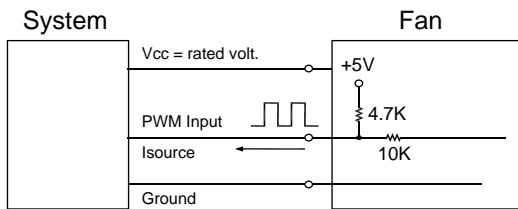

1. Period : 
$$T = \frac{1}{f_{PWM}} = t1 + t2(\text{sec})$$

2. Duty Cycle ( D.C. ) : 
$$\frac{t1}{t1+t2} * 100 = \frac{t1}{T} * 100(\%)$$

VH=2.3~5.5V

VL=0~0.8V

PWM FREQUENCY: 25KHZ

Isource=0.5mA at PWM Input Voltage 0V

The speed is default to be maximum if PWM input pin is unconnected.

Min. start up duty cycle is 10%.

■ PWM Curve

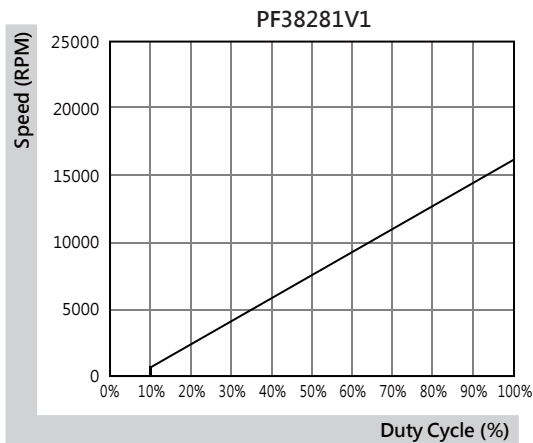

\*All model could be customized. Please contact with Sunon Sales.

\*Specifications are subject to change without notice. Please Visit SUNON website at [www.sunon.com](http://www.sunon.com) for update information.



# 38x38x28 mm

## 11.3~23.0 CFM

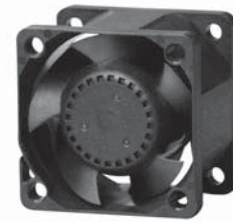

■ Specifications

Model	Bearing	Rating Voltage	Power Current	Power Consumption	Speed	Air Flow	Static Pressure	Noise	Weight	Curve
	2BALL Sleeve	(VDC)	(mA)	(WATTS)	(RPM)	(CFM)	(Inch-H <sub>2</sub> O)	(dB(A))	(g)	
PF38281BX-0000-A99	☉	12	520	6.24	20000	23.0	2.23	57.0	41.0	1
PF38281B1-0000-A99	☉	12	315	3.78	16000	18.1	1.42	51.8	41.0	2
PF38281B2-0000-A99	☉	12	290	3.48	15000	16.9	1.26	51.0	40.0	3
PF38281B3-0000-A99	☉	12	194	2.33	13000	14.9	1.00	47.3	40.0	4
PF38281B4-0000-A99	☉	12	115	1.38	10000	11.3	0.60	40.8	40.0	5

■ Function

PF38281BX / 1

- A99: AutoRestart
- F99: AutoRestart and R type
- G99: AutoRestart and F type
- H99: AutoRestart and PWM
- Q99: AutoRestart , R type and PWM
- S99: AutoRestart , F type and PWM

PF38281B2 / 3 / 4

- A99: AutoRestart
- F99: AutoRestart and R type
- G99: AutoRestart and F type

■ Air Flow-Static Pressure Characteristics

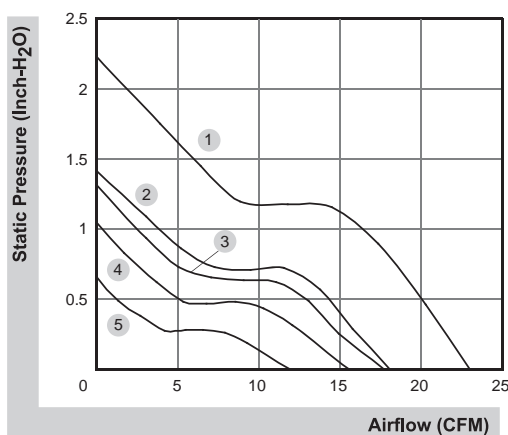

■ External dimensions(mm)

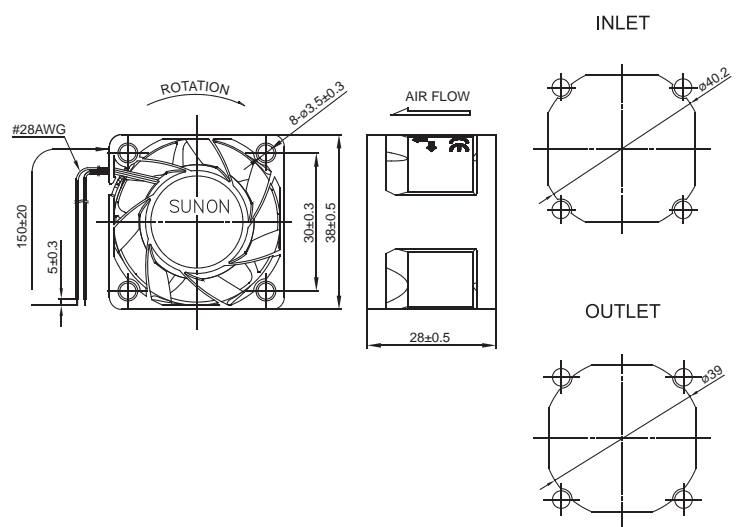

\*All model could be customized. Please contact with Sunon Sales.

\*Specifications are subject to change without notice. Please Visit SUNON website at [www.sunon.com](http://www.sunon.com) for update information.

## RD / FG Signal

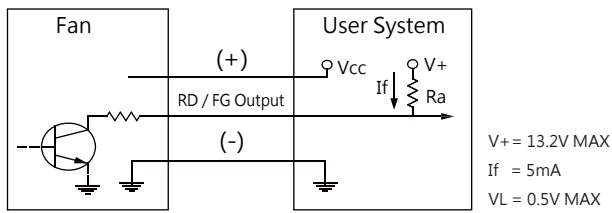

### [ RD Signal ]

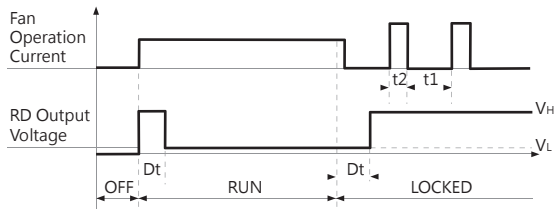

### [ FG Signal ]

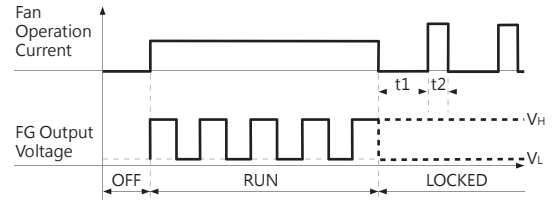
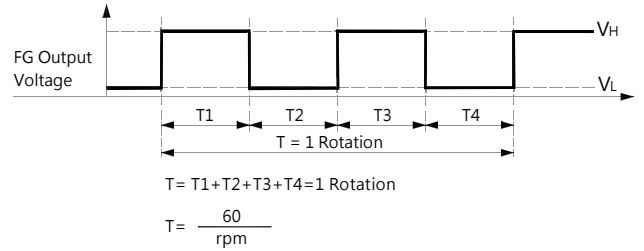

## PWM Input Signal

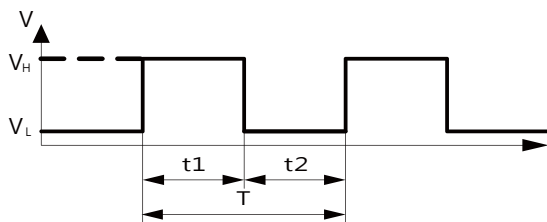
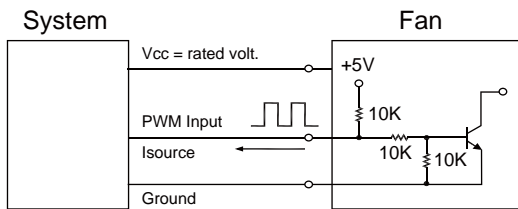

1. Period :  $T = \frac{1}{f_{\text{PWM}}} = t_1 + t_2 (\text{sec})$

2. Duty Cycle ( D.C. ) :  $\frac{t_1}{t_1 + t_2} * 100 = \frac{t_1}{T} * 100(\%)$

$V_H = 2.3 \sim 5.5V$

$V_L = 0 \sim 0.8V$

PWM FREQUENCY: 25KHZ

Isource=0.5mA at PWM Input Voltage 0V

The speed is default to be maximum if PWM input pin is unconnected.

Min. start up duty cycle is 10%.

## PWM Curve

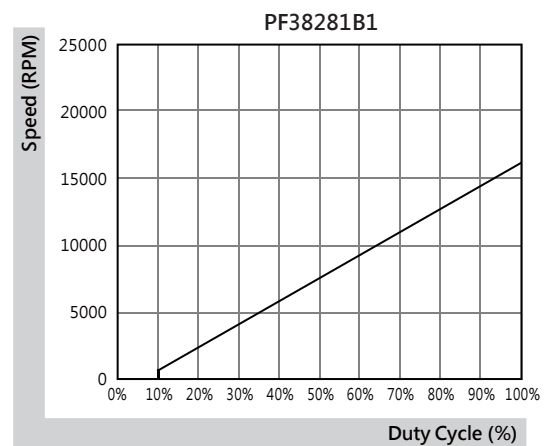
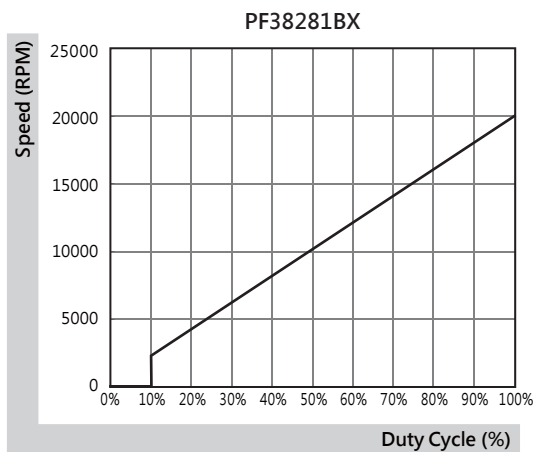

\*All model could be customized. Please contact with Sunon Sales.

\*Specifications are subject to change without notice. Please Visit SUNON website at [www.sunon.com](http://www.sunon.com) for update information.

40x40x28 mm

25.6~31.5 CFM



■ Specifications

Model	Bearing	Rating Voltage	Power Current	Power Consumption	Speed	Air Flow	Static Pressure	Noise	Weight	Curve
	2BALL Sleeve	(VDC)	(mA)	(WATTS)	(RPM)	(CFM)	(inch-H <sub>2</sub> O)	(dB(A))	(g)	
VF40281BX-0000-A9H	☉	12	1140	13.68	27000	31.5	3.95	63.7	46.0	1
VF40281B1-0000-A9H	☉	12	630	7.56	21600	25.6	2.77	58.6	46.0	2

■ Function

VF40281BX / 1

A9H: AutoRestart

G9H: AutoRestart and F type

S9H: AutoRestart , F type and PWM

■ Air Flow-Static Pressure Characteristics

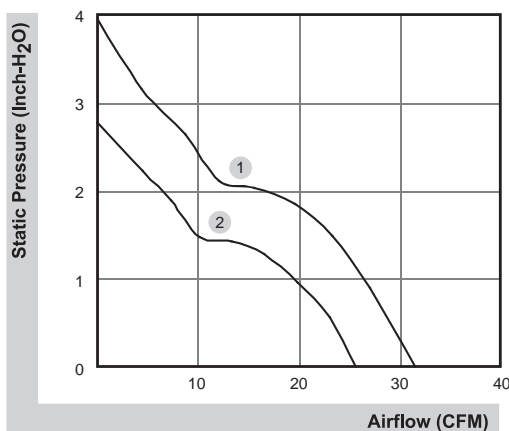

■ External dimensions(mm)

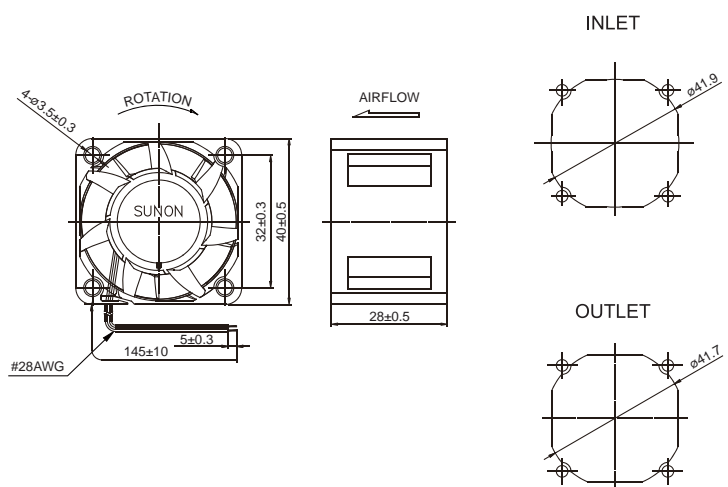

\*All model could be customized. Please contact with Sunon Sales.

\*Specifications are subject to change without notice. Please Visit SUNON website at [www.sunon.com](http://www.sunon.com) for update information.

## ■ RD / FG Signal

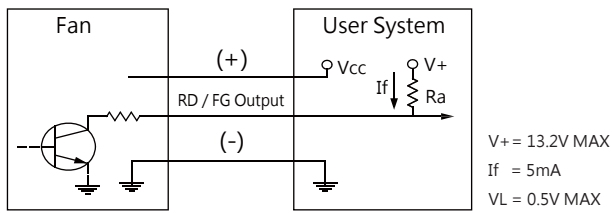

### [ RD Signal ]

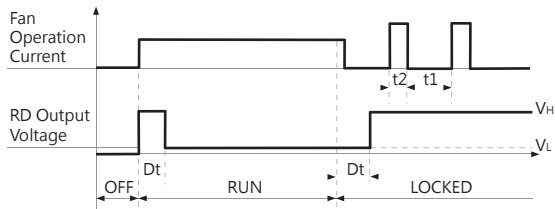

### [ FG Signal ]

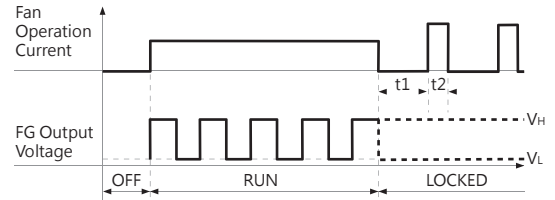
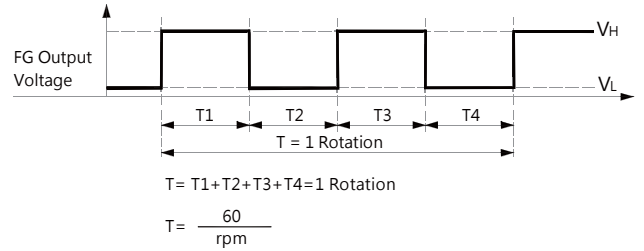

## ■ PWM Input Signal

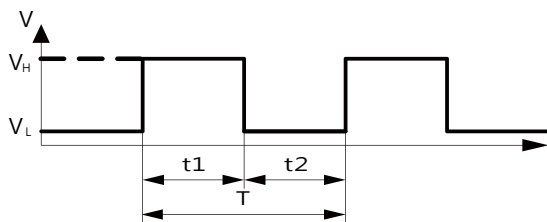
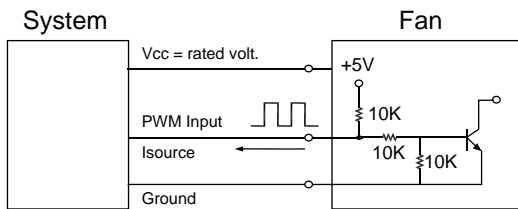

1. Period : 
$$T = \frac{1}{f_{PWM}} = t1 + t2(\text{sec})$$

2. Duty Cycle ( D.C. ) : 
$$\frac{t1}{t1 + t2} * 100 = \frac{t1}{T} * 100(\%)$$

VH=2.3~5.5V

VL=0~0.8V

PWM FREQUENCY: 25KHZ

Isource=0.5mA at PWM Input Voltage 0V

The speed is default to be maximum if PWM input pin is unconnected.

Min. start up duty cycle is 10%.

## ■ PWM Curve

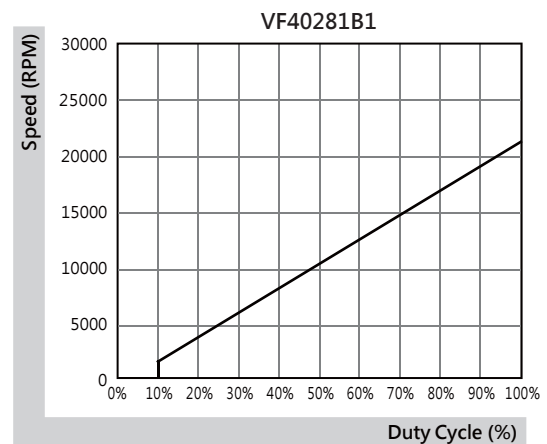
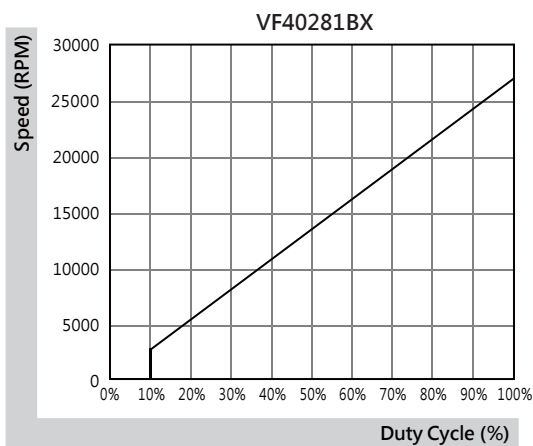

\*All model could be customized. Please contact with Sunon Sales.

\*Specifications are subject to change without notice. Please Visit SUNON website at [www.sunon.com](http://www.sunon.com) for update information.

# 40x40x28 mm

## 24.9 CFM



■ Specifications

	Bearing	Rating Voltage	Power Current	Power Consumption	Speed	Air Flow	Static Pressure	Noise	Weight	Curve
	VAPO	(VDC)	(mA)	(WATTS)	(RPM)	(CFM)	(Inch-H <sub>2</sub> O)	(dB(A))	(g)	
PF40281V1-0000-A99	●	12	740	8.88	17600	24.9	1.95	56.0	45.0	1

■ Function

PF40281V1

A99: AutoRestart

G99: AutoRestart and F type

S99: AutoRestart , F type and PWM

■ Air Flow-Static Pressure Characteristics

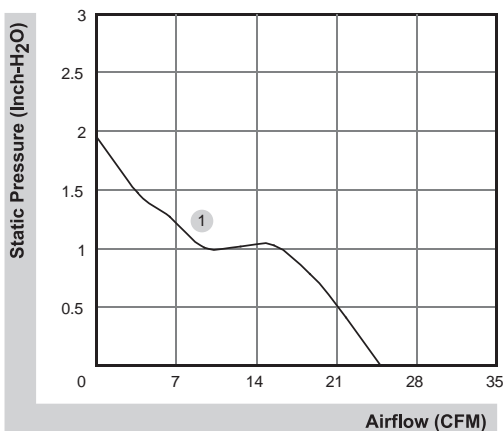

■ External dimensions(mm)

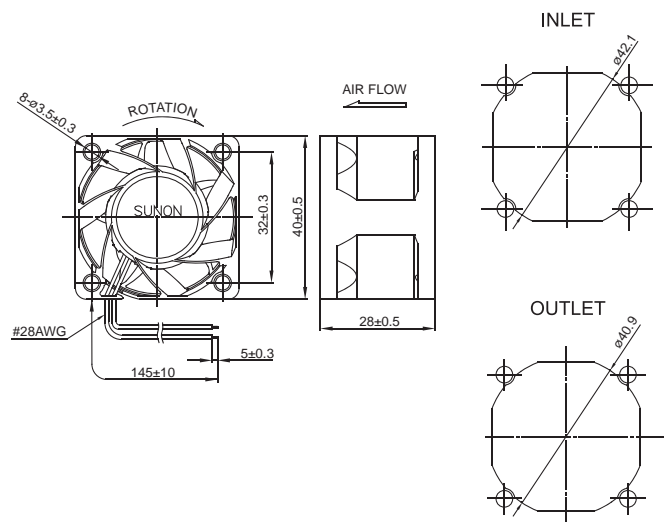

\*All model could be customized. Please contact with Sunon Sales.

\*Specifications are subject to change without notice. Please Visit SUNON website at [www.sunon.com](http://www.sunon.com) for update information.

■ FG Signal

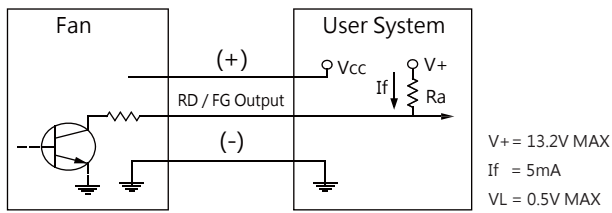

[ RD Signal ]

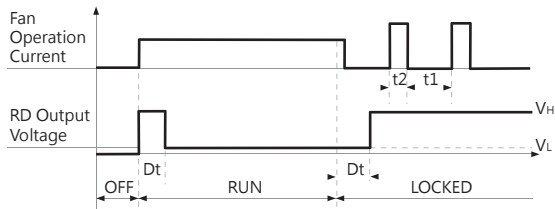

[ FG Signal ]

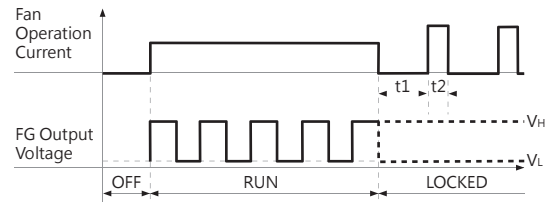
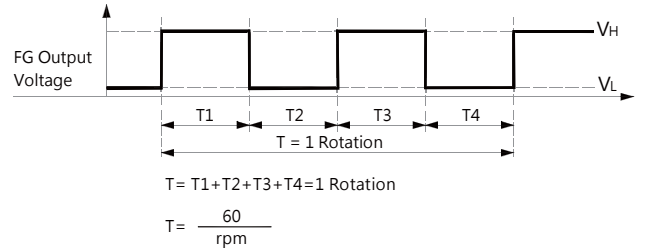

■ PWM Input Signal

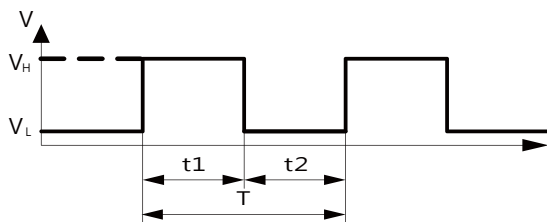
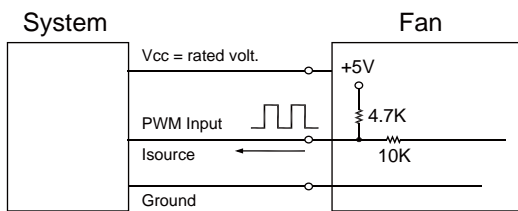

1. Period :  $T = \frac{1}{f_{\text{PWM}}} = t1 + t2(\text{sec})$

2. Duty Cycle ( D.C. ) :  $\frac{t1}{t1+t2} * 100 = \frac{t1}{T} * 100(\%)$

VH=2.3~5.5V

VL=0~0.8V

PWM FREQUENCY: 25KHZ

Isource=0.5mA at PWM Input Voltage 0V

The speed is default to be maximum if PWM input pin is unconnected.

Min. start up duty cycle is 10%.

■ PWM Curve

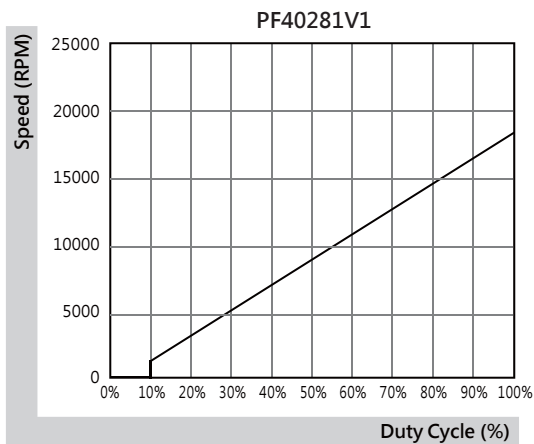

\*All model could be customized. Please contact with Sunon Sales.

\*Specifications are subject to change without notice. Please Visit SUNON website at [www.sunon.com](http://www.sunon.com) for update information.

# 40x40x28 mm

## 12.8~31.3 CFM



■ Specifications

Model	Bearing	Rating Voltage	Power Current	Power Consumption	Speed	Air Flow	Static Pressure	Noise	Weight	Curve
	2BALL Sleeve	(VDC)	(mA)	(WATTS)	(RPM)	(CFM)	(Inch-H <sub>2</sub> O)	(dB(A))	(g)	
PF40281BX-0000-A99	☉	12	900	10.80	22000	31.3	2.81	62.0	42.0	1
PF40281B1-0000-A99	☉	12	510	6.12	17600	24.9	1.95	56.0	42.0	2
PF40281B2-0000-A99	☉	12	246	2.96	13000	18.0	1.10	48.7	45.0	3
PF40281B3-0000-A99	☉	12	162	1.95	11000	15.4	0.78	43.9	45.0	4
PF40281B4-0000-A99	☉	12	116	1.40	9200	12.8	0.54	39.9	45.0	5

■ Function

PF40281BX / 1

A99: AutoRestart  
 F99: AutoRestart and R type  
 G99: AutoRestart and F type  
 H99: AutoRestart and PWM  
 Q99: AutoRestart , R type and PWM  
 S99: AutoRestart , F type and PWM

PF40281B2 / 3 / 4

A99: AutoRestart  
 F99: AutoRestart and R type  
 G99: AutoRestart and F type

■ Air Flow-Static Pressure Characteristics

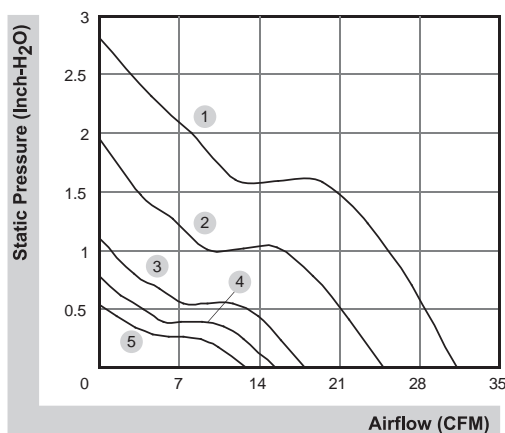

■ External dimensions(mm)

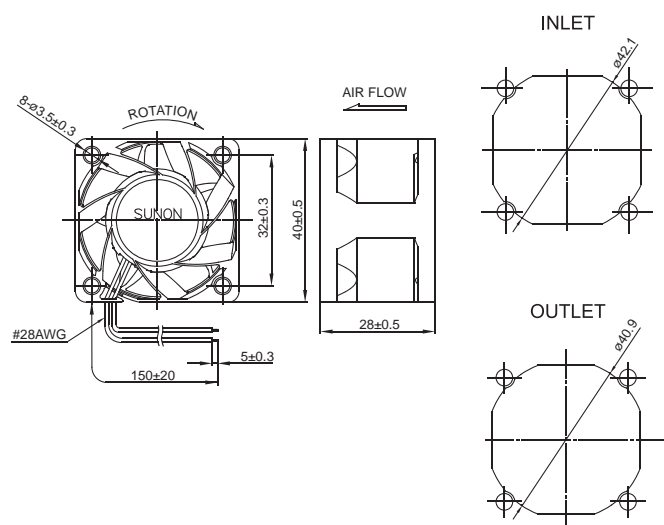

\*All model could be customized. Please contact with Sunon Sales.

\*Specifications are subject to change without notice. Please Visit SUNON website at [www.sunon.com](http://www.sunon.com) for update information.

■ FG Signal

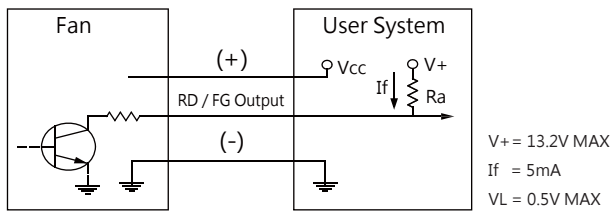

[ RD Signal ]

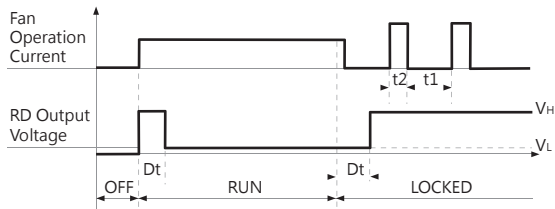

[ FG Signal ]

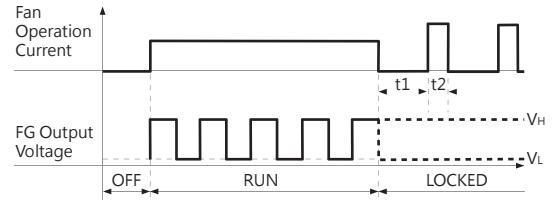
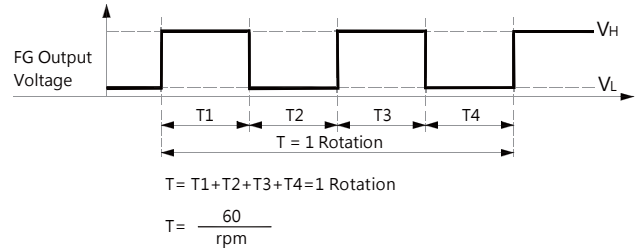

■ PWM Input Signal

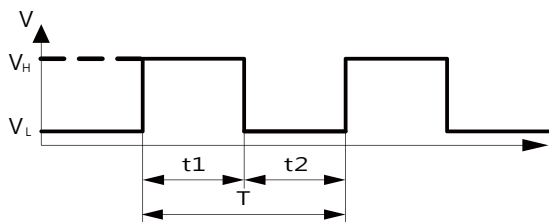
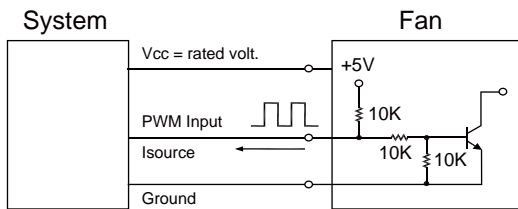

1. Period :  $T = \frac{1}{f_{\text{PWM}}} = t_1 + t_2(\text{sec})$

2. Duty Cycle ( D.C. ) :  $\frac{t_1}{t_1 + t_2} * 100 = \frac{t_1}{T} * 100(\%)$

VH=2.3~5.5V

VL=0~0.8V

PWM FREQUENCY: 25KHZ

Isource=0.5mA at PWM Input Voltage 0V

The speed is default to be maximum if PWM input pin is unconnected.

Min. start up duty cycle is 10%.

■ PWM Curve

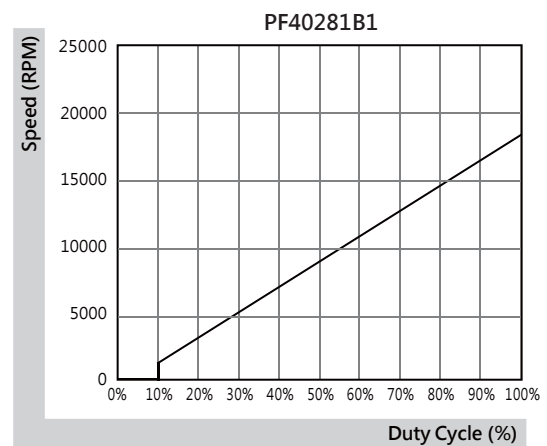
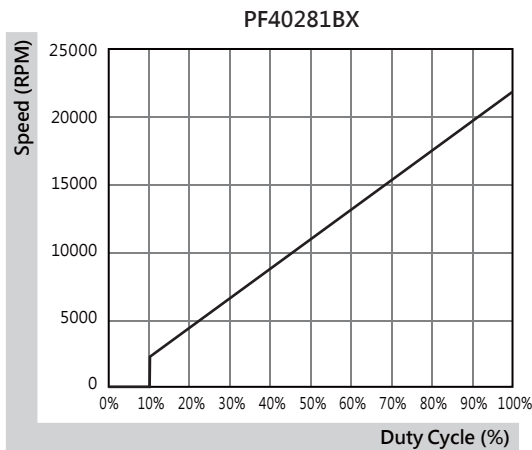

\*All model could be customized. Please contact with Sunon Sales.

\*Specifications are subject to change without notice. Please Visit SUNON website at [www.sunon.com](http://www.sunon.com) for update information.



# 40x40x56 mm

## 26.9~31.7 CFM

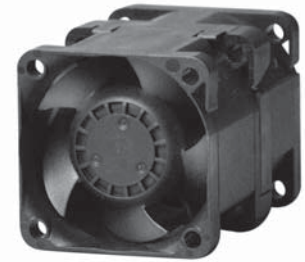

■ Specifications

Model	Bearing	Rating Voltage	Power Current	Power Consumption	Speed in / out	Air Flow	Static Pressure	Noise	Weight	Curve
	2BALL Sleeve	(VDC)	(mA)	(WATTS)	(RPM)	(CFM)	(Inch-H <sub>2</sub> O)	(dB(A))	(g)	
PF40561BX-0000-A99	☉	12	1390	16.68	21500/18000	31.7	3.60	65.9	87.0	1
PF40561B1-0000-A99	☉	12	890	10.68	18000/15000	26.9	2.56	62.3	87.0	2

■ Function

PF40561BX / 1

A99: AutoRestart

F99: AutoRestart and R type

G99: AutoRestart and F type

H99: AutoRestart and PWM

Q99: AutoRestart , R type and PWM

S99: AutoRestart , F type and PWM

■ Air Flow-Static Pressure Characteristics

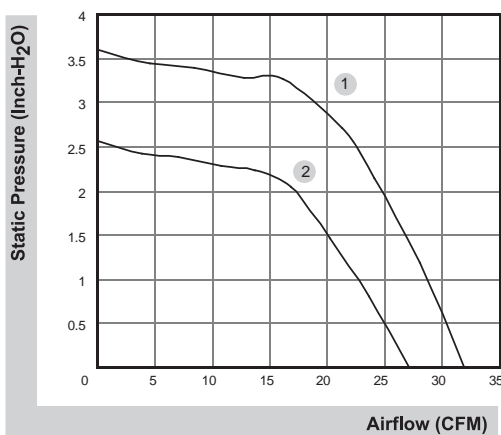

■ External dimensions(mm)

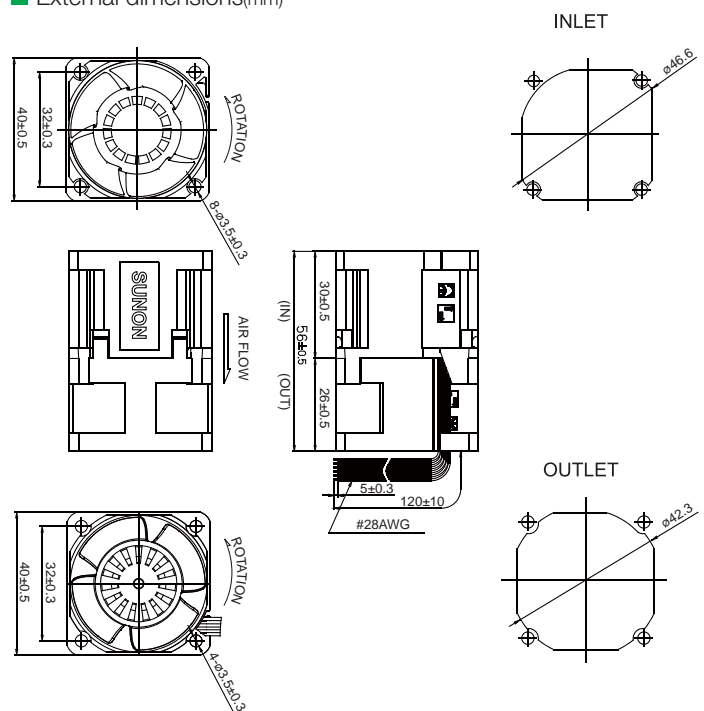

\*All model could be customized. Please contact with Sunon Sales.

\*Specifications are subject to change without notice. Please Visit SUNON website at [www.sunon.com](http://www.sunon.com) for update information.

■ FG Signal

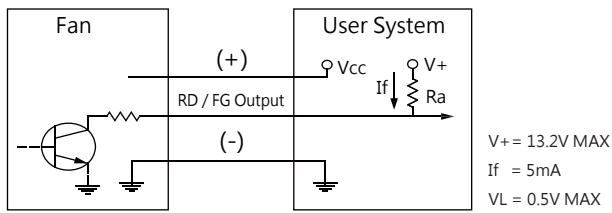

[ FG Signal ]

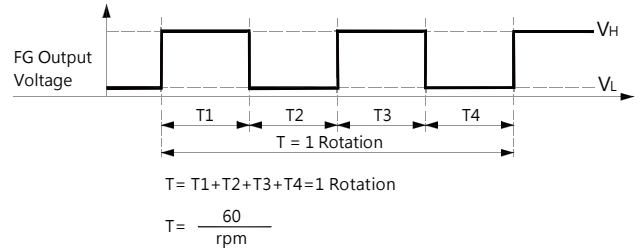

[ RD Signal ]

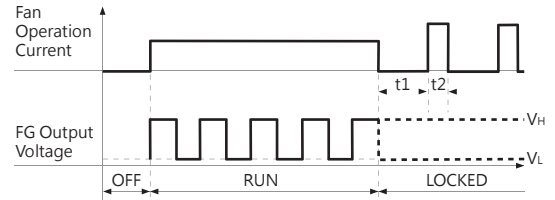
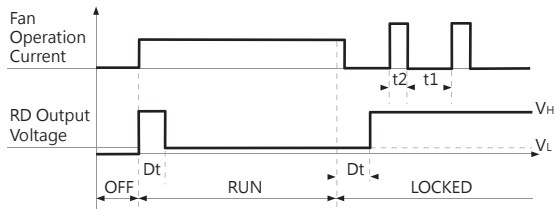

■ PWM Input Signal

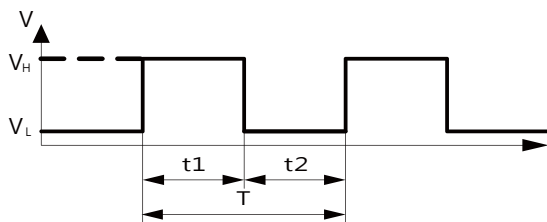
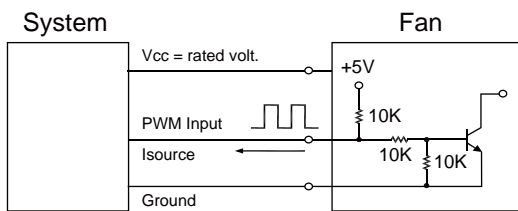

1. Period :  $T = \frac{1}{f_{PWM}} = t1 + t2(\text{sec})$

2. Duty Cycle ( D.C. ) :  $\frac{t1}{t1+t2} * 100 = \frac{t1}{T} * 100(\%)$

VH=2.3~5.5V

VL=0~0.8V

PWM FREQUENCY: 25KHZ

Isource=0.5mA at PWM Input Voltage 0V

The speed is default to be maximum if PWM input pin is unconnected.

Min. start up duty cycle is 10%.

■ PWM Curve

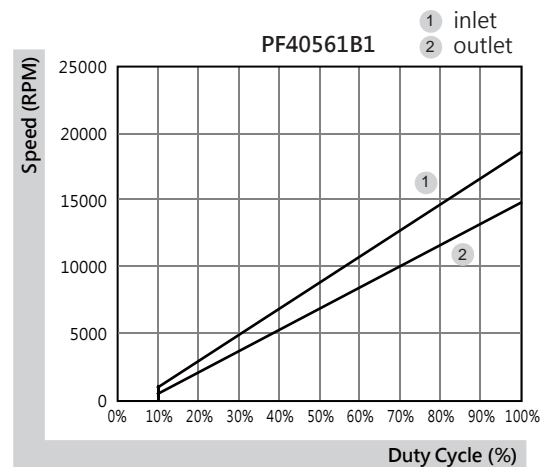
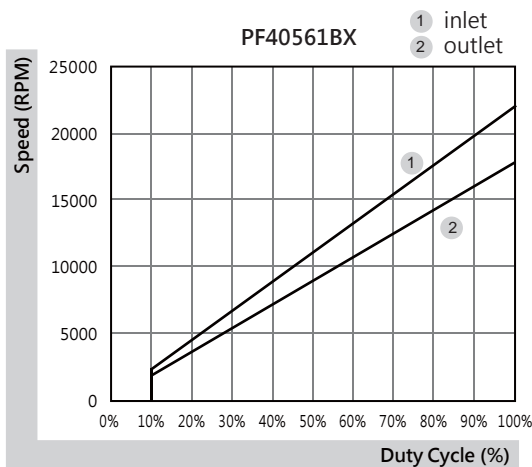

\*All model could be customized. Please contact with Sunon Sales.

\*Specifications are subject to change without notice. Please Visit SUNON website at [www.sunon.com](http://www.sunon.com) for update information.

# 60x60x38 mm

## 60.6~75.2 CFM



■ Specifications

Model	Bearing	Rating Voltage	Power Current	Power Consumption	Speed	Air Flow	Static Pressure	Noise	Weight	Curve
	2BALL Sleeve	(VDC)	(mA)	(WATTS)	(RPM)	(CFM)	(Inch-H <sub>2</sub> O)	(dB(A))	(g)	
PF60381BX-0000-A99	☉	12	2500	30.00	16500	75.2	3.28	67.6	127.0	1
PF60381B1-0000-A99	☉	12	1200	14.40	13200	60.6	2.13	61.2	127.0	2

■ Function

PF60381BX / 1

A99: AutoRestart

F99: AutoRestart and R type

G99: AutoRestart and F type

H99: AutoRestart and PWM

Q99: AutoRestart , R type and PWM

S99: AutoRestart , F type and PWM

■ Air Flow-Static Pressure Characteristics

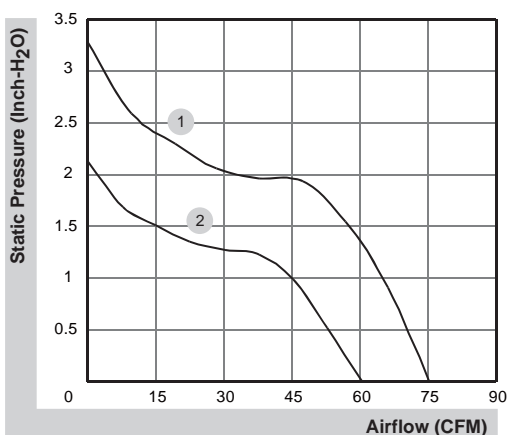

■ External dimensions(mm)

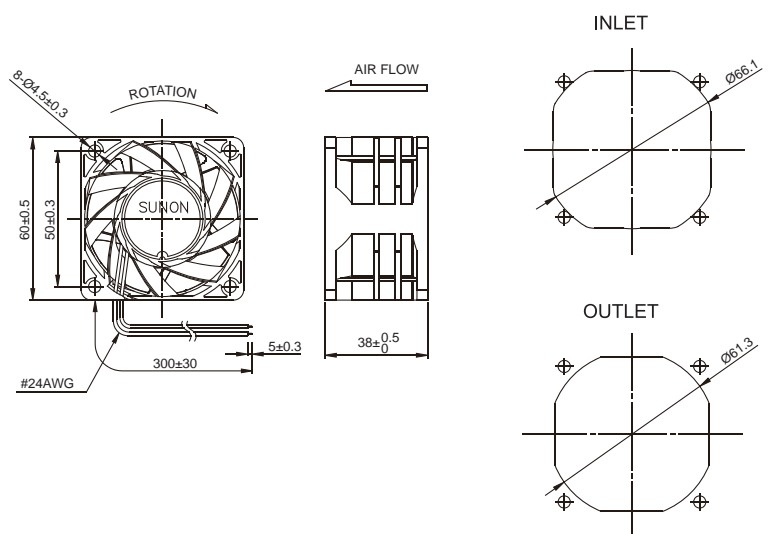

\*All model could be customized. Please contact with Sunon Sales.

\*Specifications are subject to change without notice. Please Visit SUNON website at [www.sunon.com](http://www.sunon.com) for update information.

■ FG Signal

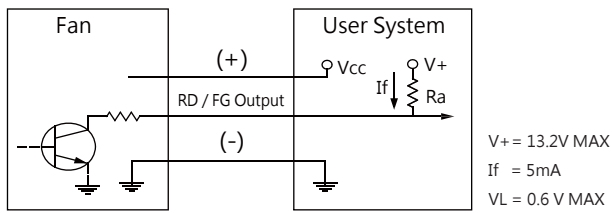

[ FG Signal ]

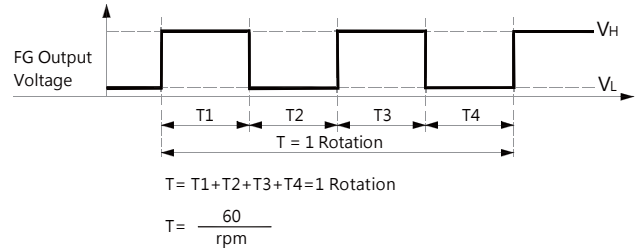

[ RD Signal ]

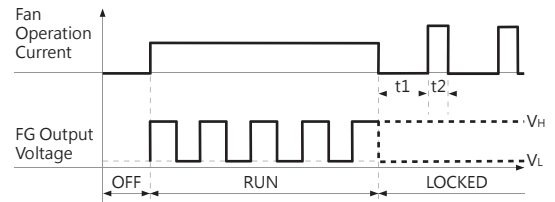
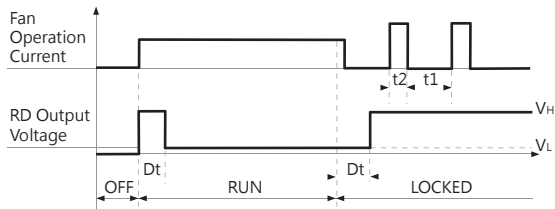

■ PWM Input Signal

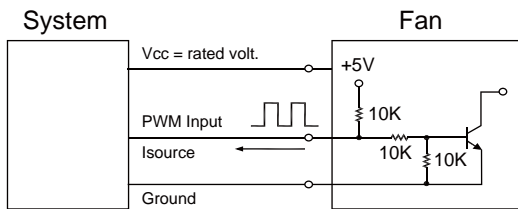

1. Period : 
$$T = \frac{1}{f_{PWM}} = t1 + t2(\text{sec})$$

2. Duty Cycle ( D.C. ) : 
$$\frac{t1}{t1 + t2} * 100 = \frac{t1}{T} * 100(\%)$$

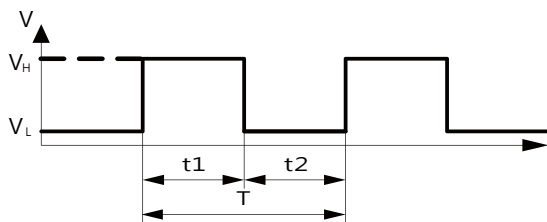

VH=2.3~5.5V

VL=0~0.8V

PWM FREQUENCY: 25KHZ

Isource=0.5mA at PWM Input Voltage 0V

The speed is default to be maximum if PWM input pin is unconnected.

Min. start up duty cycle is 10%.

■ PWM Curve

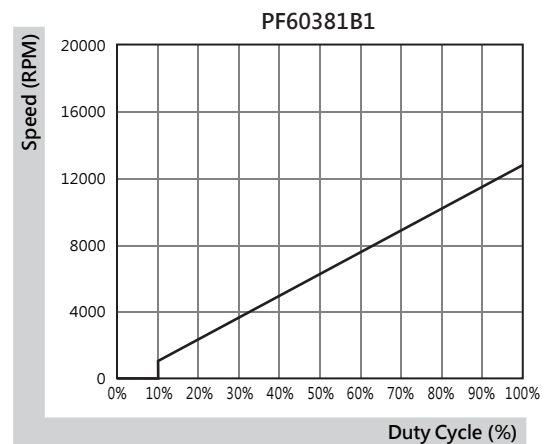
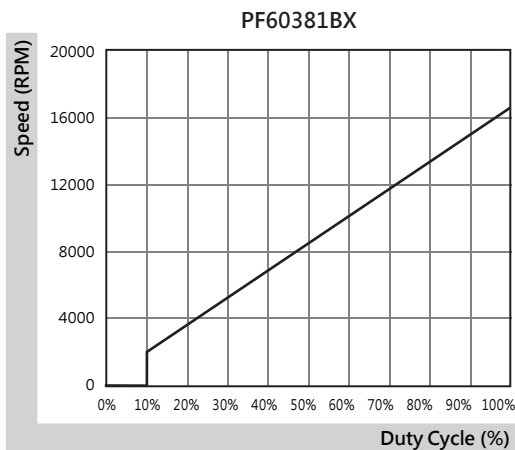

\*All model could be customized. Please contact with Sunon Sales.

\*Specifications are subject to change without notice. Please Visit SUNON website at [www.sunon.com](http://www.sunon.com) for update information.

60x60x38 mm

54.1~67.8 CFM



■ Specifications

Model	Bearing	Rating Voltage	Power Current	Power Consumption	Speed	Air Flow	Static Pressure	Noise	Weight	Curve
	2BALL Sleeve	(VDC)	(mA)	(WATTS)	(RPM)	(CFM)	(inch-H <sub>2</sub> O)	(dB(A))	(g)	
VF60381BX-0000-A9H	☉	12	1900	22.80	22800	67.8	4.84	64.1	120.0	1
VF60381B1-0000-A9H	☉	12	1000	12.00	18300	54.1	4.23	60.9	120.0	2

■ Function

VF60381BX / 1

A9H: AutoRestart

G9H: AutoRestart and F type

S9H: AutoRestart , F type and PWM

■ Air Flow-Static Pressure Characteristics

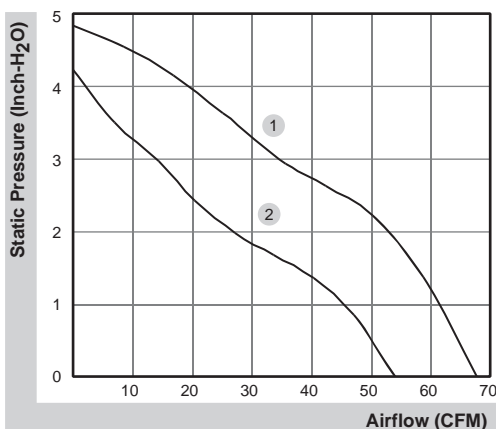

■ External dimensions(mm)

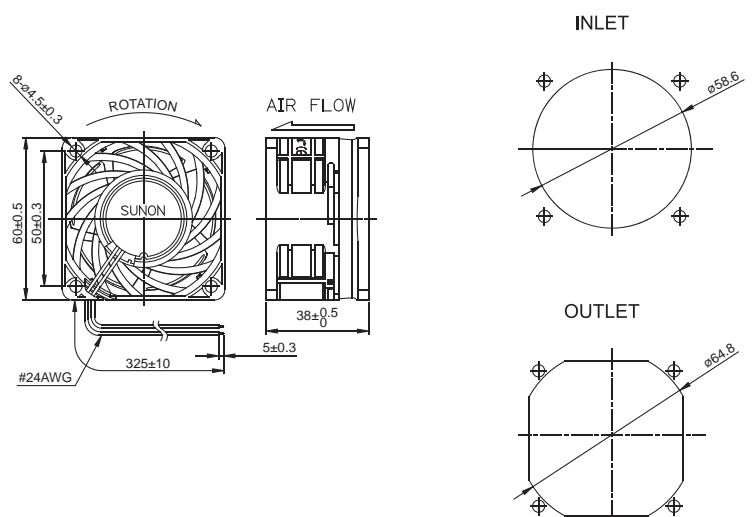

\*All model could be customized. Please contact with Sunon Sales.

\*Specifications are subject to change without notice. Please Visit SUNON website at [www.sunon.com](http://www.sunon.com) for update information.

■ RD / FG Signal

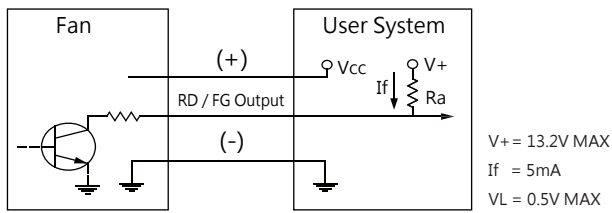

[ RD Signal ]

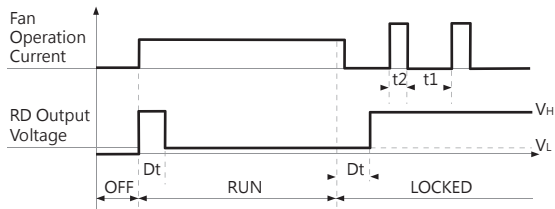

[ FG Signal ]

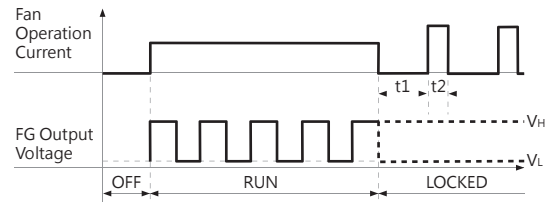
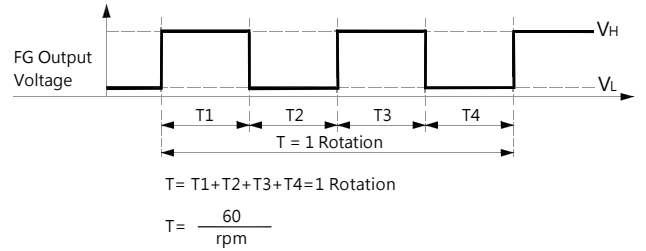

■ PWM Input Signal

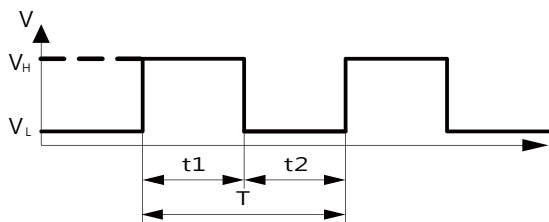
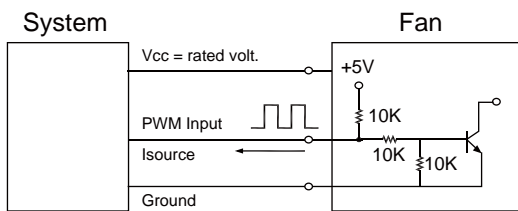

1. Period :  $T = \frac{1}{f_{PWM}} = t1 + t2(\text{sec})$

2. Duty Cycle ( D.C. ) :  $\frac{t1}{t1+t2} * 100 = \frac{t1}{T} * 100(\%)$

VH=2.3~5.5V

VL=0~0.8V

PWM FREQUENCY: 25KHZ

Isource=0.5mA at PWM Input Voltage 0V

The speed is default to be maximum if PWM input pin is unconnected.

Min. start up duty cycle is 10%.

■ PWM Curve

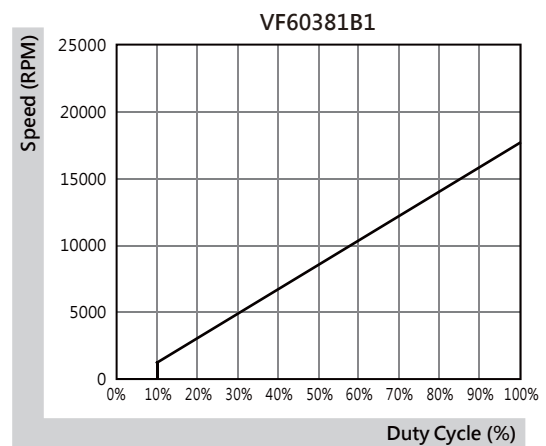
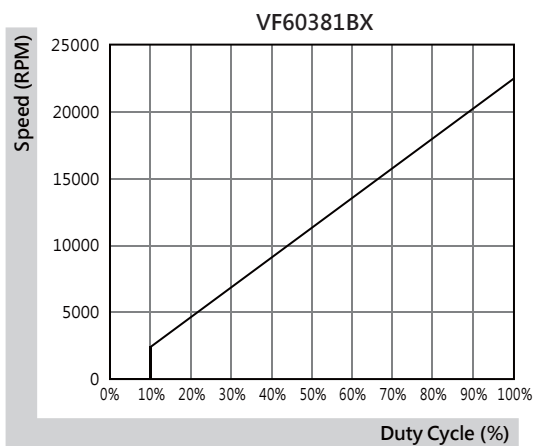

\*All model could be customized. Please contact with Sunon Sales.

\*Specifications are subject to change without notice. Please Visit SUNON website at [www.sunon.com](http://www.sunon.com) for update information.

# 60x60x56 mm

## 58.5~72.9 CFM

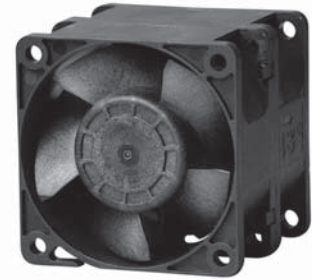

### Specifications

Model	Bearing	Rating Voltage	Power Current	Power Consumption	Speed in / out	Air Flow	Static Pressure	Noise	Weight	Curve
	2BALL Sleeve	(VDC)	(mA)	(WATTS)	(RPM)	(CFM)	(inch-H <sub>2</sub> O)	(dB(A))	(g)	
PF60561BX-0000-A9H	☉	12	2500	30.00	15300/14300	72.9	3.44	71.7	172.0	1
PF60561B1-0000-A9H	☉	12	1400	16.80	12300/11500	58.5	2.35	67.0	172.0	2

### Function

PF60561BX / 1

A9H: AutoRestart

F9H: AutoRestart and R type

G9H: AutoRestart and F type

H9H: AutoRestart and PWM

Q9H: AutoRestart , R type and PWM

S9H: AutoRestart , F type and PWM

### External dimensions(mm)

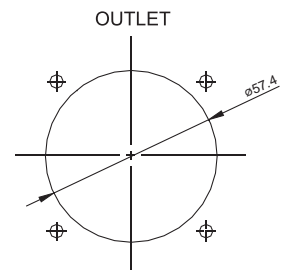
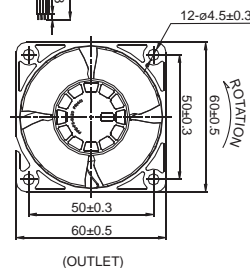
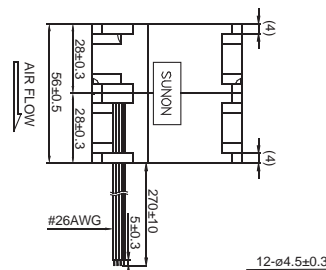
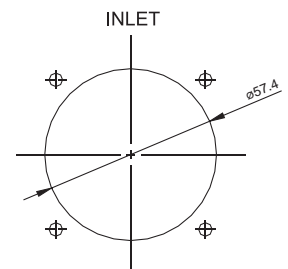
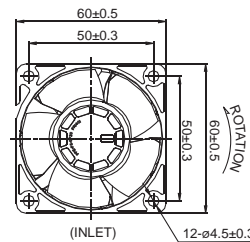

### Air Flow-Static Pressure Characteristics

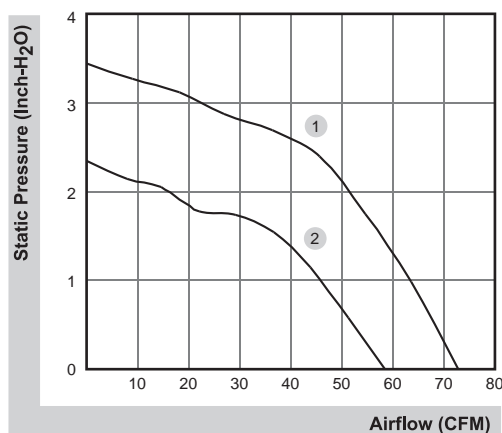

\*All model could be customized. Please contact with Sunon Sales.

\*Specifications are subject to change without notice. Please Visit SUNON website at [www.sunon.com](http://www.sunon.com) for update information.

■ RD / FG Signal

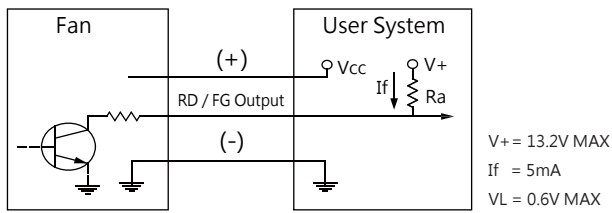

[ RD Signal ]

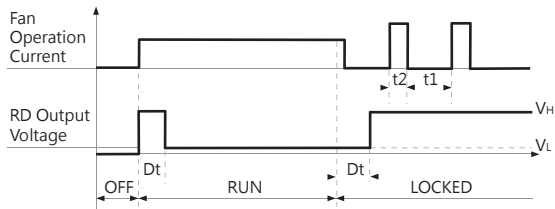

[ FG Signal ]

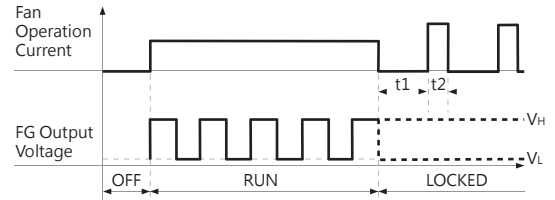
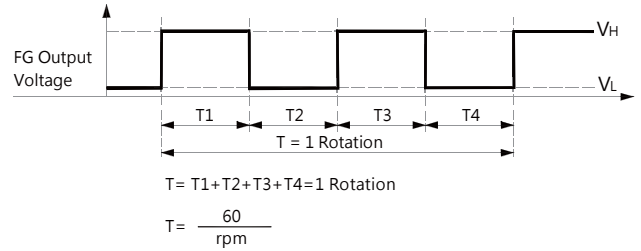

■ PWM Input Signal

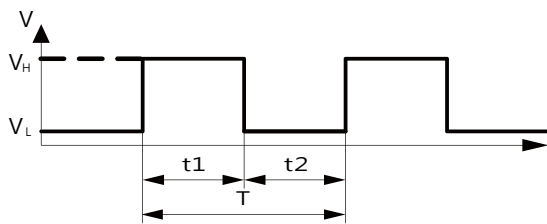
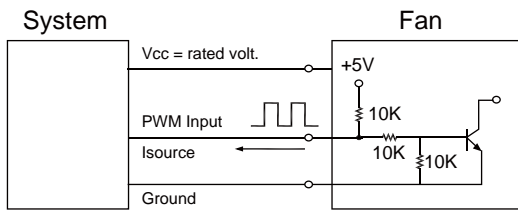

1. Period : 
$$T = \frac{1}{f_{PWM}} = t1 + t2(\text{sec})$$

2. Duty Cycle ( D.C. ) : 
$$\frac{t1}{t1+t2} * 100 = \frac{t1}{T} * 100(\%)$$

VH=2.3~5.5V

VL=0~0.8V

PWM FREQUENCY: 25KHZ

Isource=0.5mA at PWM Input Voltage 0V

The speed is default to be maximum if PWM input pin is unconnected.

Min. start up duty cycle is 10%.

■ PWM Curve

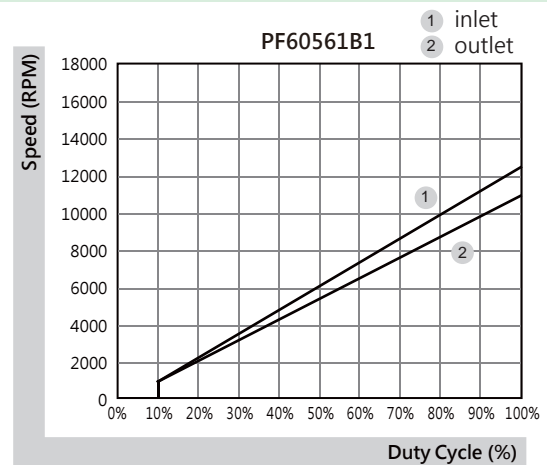
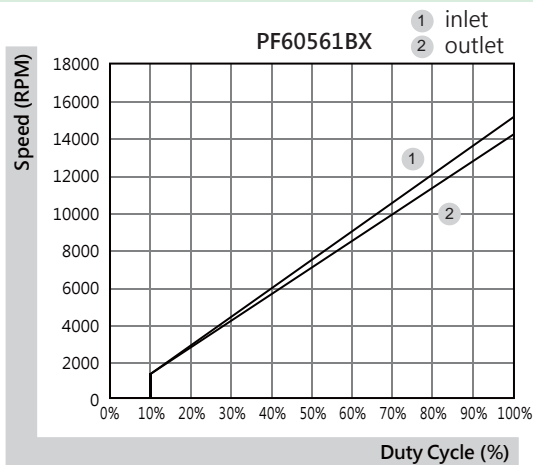

\*All model could be customized. Please contact with Sunon Sales.

\*Specifications are subject to change without notice. Please Visit SUNON website at [www.sunon.com](http://www.sunon.com) for update information.



# 60x60x76 mm

## 58.7~73.2 CFM



### Specifications

Model	Bearing	Rating Voltage	Power Current	Power Consumption	Speed in / out	Air Flow	Static Pressure	Noise	Weight	Curve
	2BALL Sleeve	(VDC)	(mA)	(WATTS)	(RPM)	(CFM)	(inch-H <sub>2</sub> O)	(dB(A))	(g)	
PF60761BX-0000-A99	☉	12	2800	33.60	18200/14700	73.2	3.96	68.6	270.0	1
PF60761B1-0000-A99	☉	12	1600	19.20	14600/11700	58.7	2.54	62.8	270.0	2

### Function

PF60761BX / 1

A99: AutoRestart

F99: AutoRestart and R type

G99: AutoRestart and F type

H99: AutoRestart and PWM

Q99: AutoRestart , R type and PWM

S99: AutoRestart , F type and PWM

### External dimensions(mm)

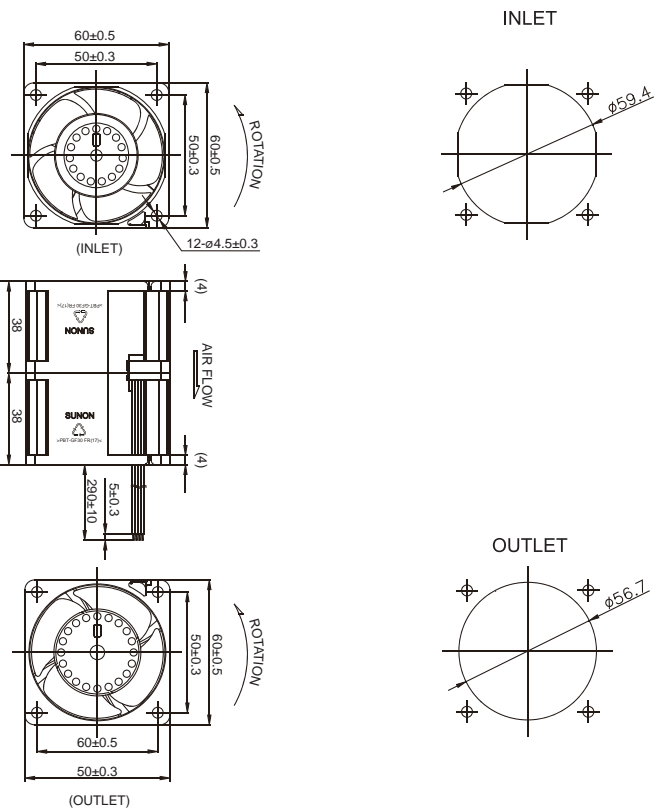

### Air Flow-Static Pressure Characteristics

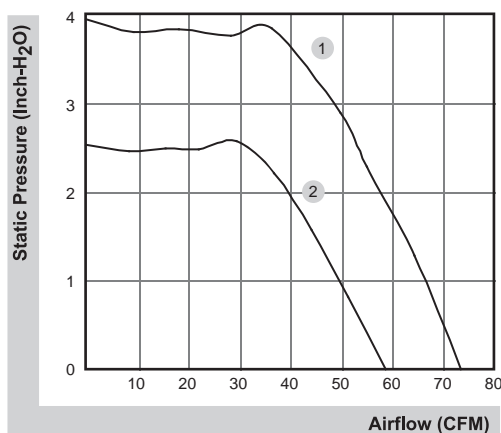

\*All model could be customized. Please contact with Sunon Sales.

\*Specifications are subject to change without notice. Please Visit SUNON website at [www.sunon.com](http://www.sunon.com) for update information.

## RD / FG Signal

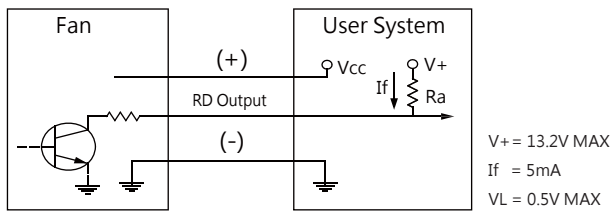

### [ RD Signal ]

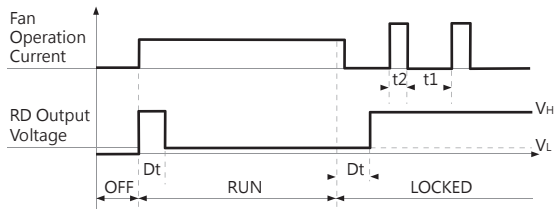

### [ FG Signal ]

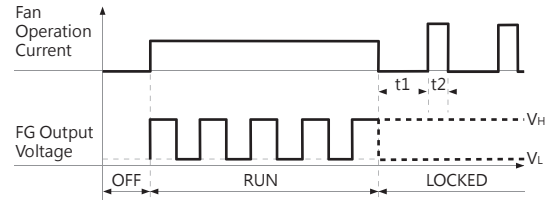
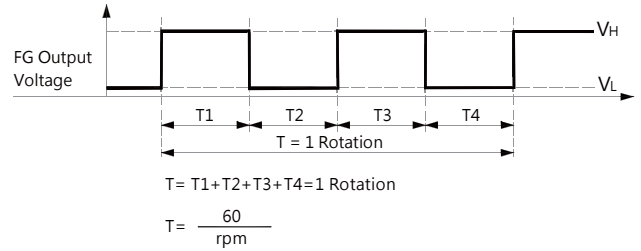

## PWM Input Signal

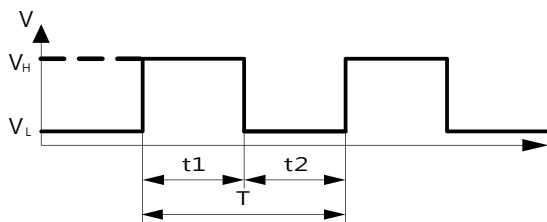
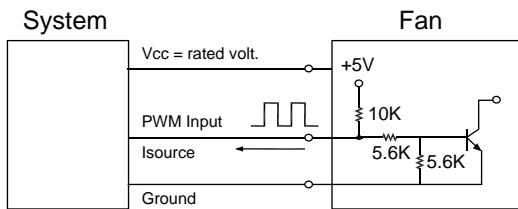

1. Period : 
$$T = \frac{1}{f_{PWM}} = t1 + t2(\text{sec})$$

2. Duty Cycle ( D.C. ) : 
$$\frac{t1}{t1+t2} * 100 = \frac{t1}{T} * 100(\%)$$

VH=2.3~5.5V

VL=0~0.8V

PWM FREQUENCY: 25KHZ

Isource=0.5mA at PWM Input Voltage 0V

The speed is default to be maximum if PWM input pin is unconnected.

Min. start up duty cycle is 10%.

## PWM Curve

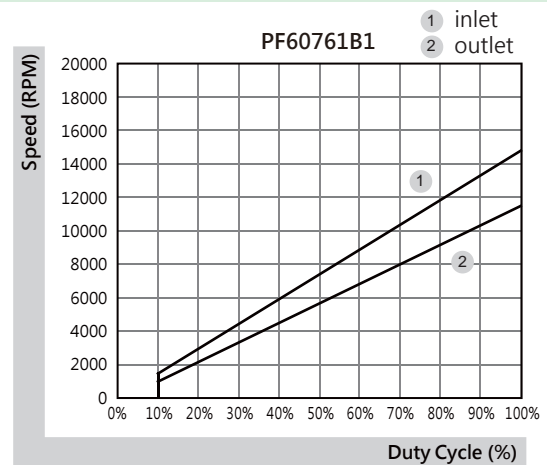
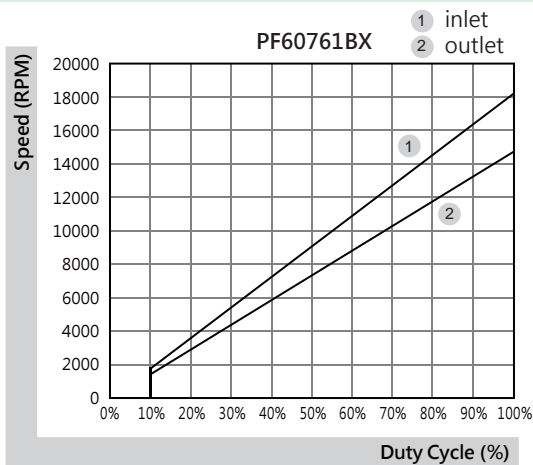

\*All model could be customized. Please contact with Sunon Sales.

\*Specifications are subject to change without notice. Please Visit SUNON website at [www.sunon.com](http://www.sunon.com) for update information.

80x80x38 mm

113.9~141.9 CFM

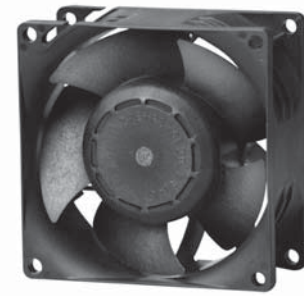

■ Specifications

Model	Bearing	Rating Voltage	Power Current	Power Consumption	Speed	Air Flow	Static Pressure	Noise	Weight	Curve
	2BALL Sleeve	(VDC)	(mA)	(WATTS)	(RPM)	(CFM)	(inch-H <sub>2</sub> O)	(dB(A))	(g)	
PF80381BX-0000-A99	☉	12	4000	48.00	14000	141.9	3.20	72.1	195.0	1
PF80381B1-0000-A99	☉	12	2000	24.00	11200	113.9	2.23	64.8	195.0	2

■ Function

PF80381BX / 1

A99: AutoRestart

F99: AutoRestart and R type

G99: AutoRestart and F type

H99: AutoRestart and PWM

Q99: AutoRestart , R type and PWM

S99: AutoRestart , F type and PWM

■ Air Flow-Static Pressure Characteristics

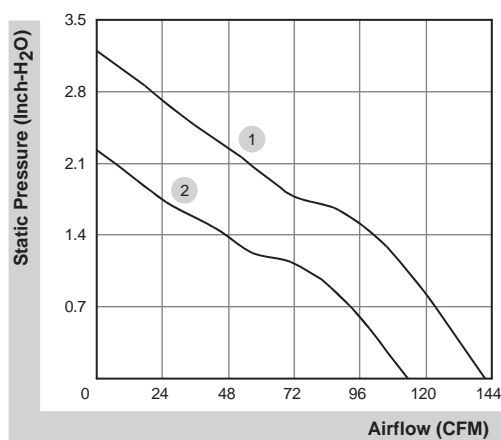

■ External dimensions(mm)

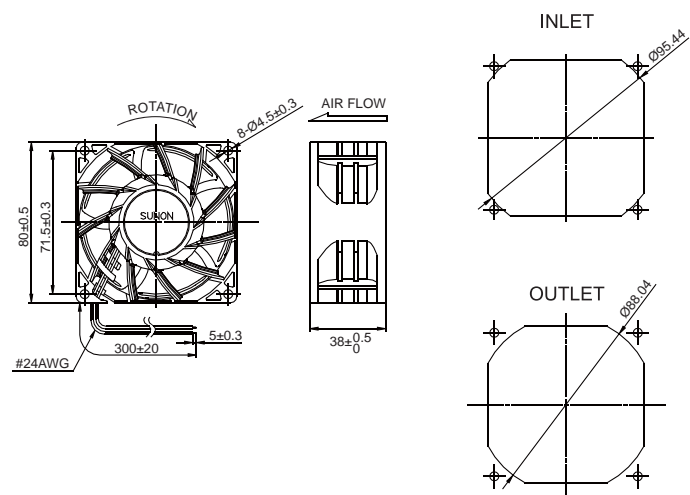

\*All model could be customized. Please contact with Sunon Sales.

\*Specifications are subject to change without notice. Please Visit SUNON website at [www.sunon.com](http://www.sunon.com) for update information.

■ FG Signal

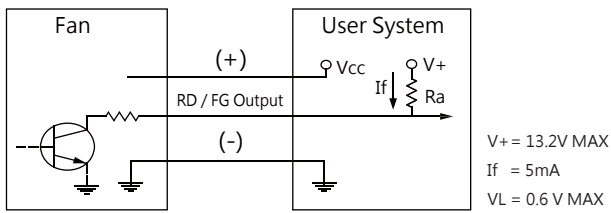

[ FG Signal ]

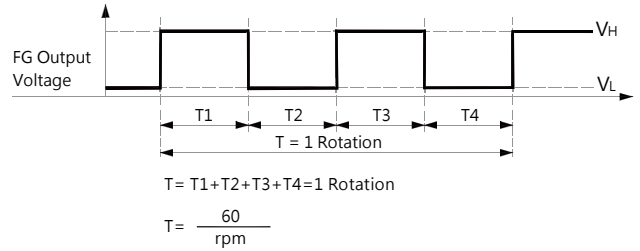

[ RD Signal ]

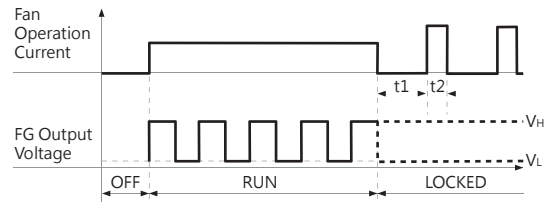
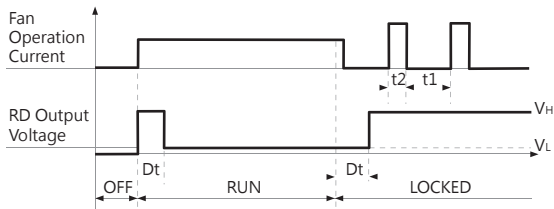

■ PWM Input Signal

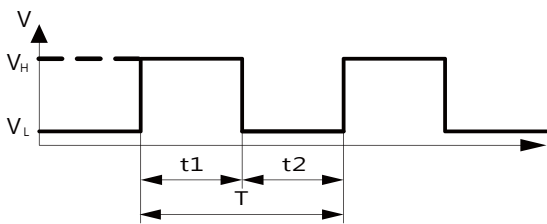
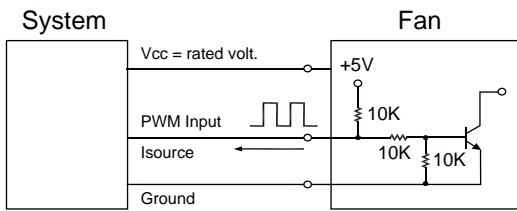

1. Period :  $T = \frac{1}{f_{PWM}} = t1 + t2(\text{sec})$

2. Duty Cycle ( D.C. ) :  $\frac{t1}{t1+t2} * 100 = \frac{t1}{T} * 100(\%)$

VH=2.3~5.5V

VL=0~0.8V

PWM FREQUENCY: 25KHZ

Isource=0.5mA at PWM Input Voltage 0V

The speed is default to be maximum if PWM input pin is unconnected.

Min. start up duty cycle is 10%.

■ PWM Curve

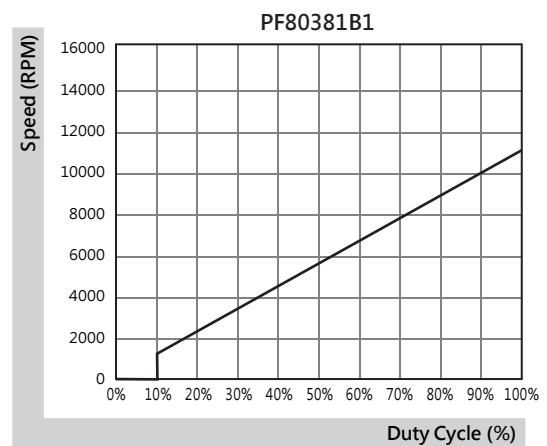
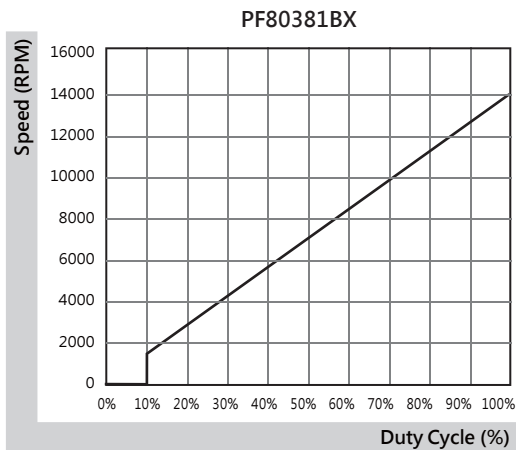

\*All model could be customized. Please contact with Sunon Sales.

\*Specifications are subject to change without notice. Please Visit SUNON website at [www.sunon.com](http://www.sunon.com) for update information.

# 80x80x38 mm

## 105.8~134.3 CFM

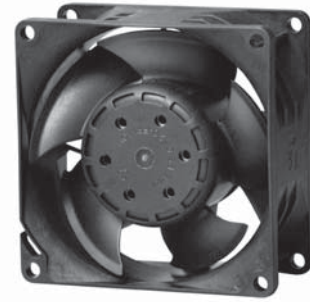

### Specifications

Model	Bearing	Rating Voltage	Power Current	Power Consumption	Speed	Air Flow	Static Pressure	Noise	Weight	Curve
	2BALL Sleeve	(VDC)	(mA)	(WATTS)	(RPM)	(CFM)	(inch-H <sub>2</sub> O)	(dB(A))	(g)	
PF80384BX-0000-A99	☉	48	700	33.60	12900	134.3	3.35	67.5	204.0	1
PF80384B1-0000-A99	☉	48	380	18.24	10500	105.8	2.46	62.6	204.0	2

### Function

PF80384BX / 1

A99: AutoRestart

F99: AutoRestart and R type

G99: AutoRestart and F type

H99: AutoRestart and PWM

Q99: AutoRestart , R type and PWM

S99: AutoRestart , F type and PWM

### Air Flow-Static Pressure Characteristics

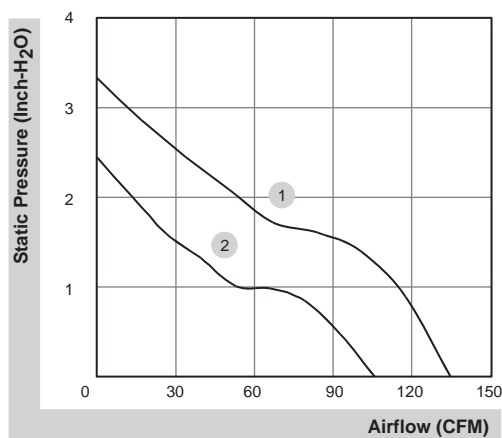

### External dimensions(mm)

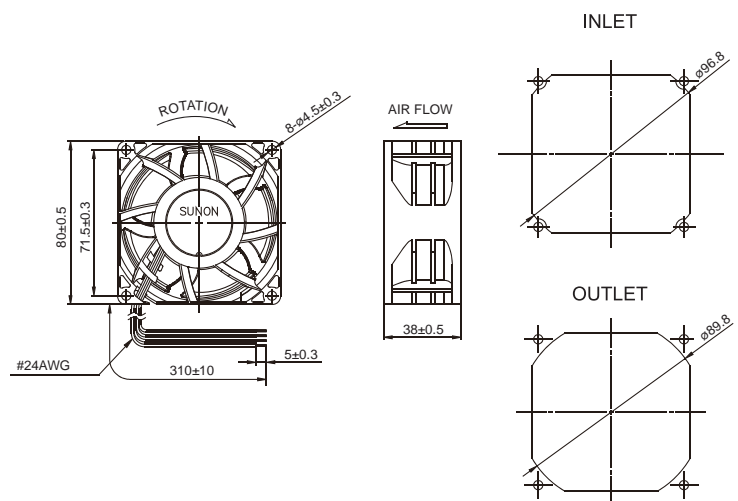

\*All model could be customized. Please contact with Sunon Sales.

\*Specifications are subject to change without notice. Please Visit SUNON website at [www.sunon.com](http://www.sunon.com) for update information.

■ FG Signal

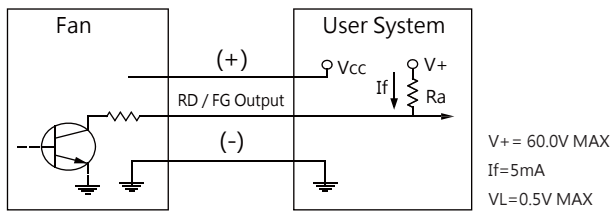

[ RD Signal ]

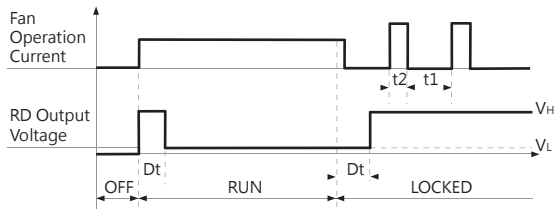

[ FG Signal ]

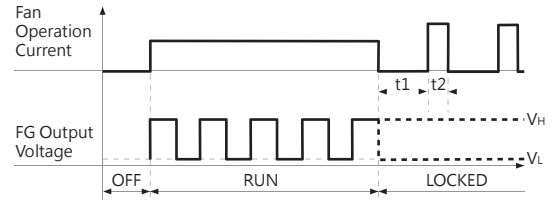
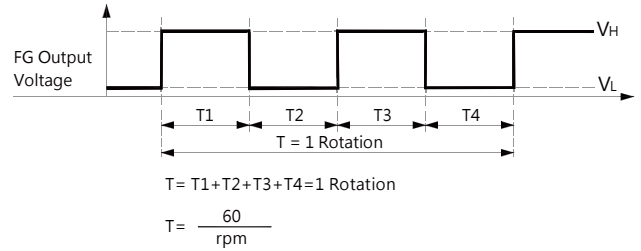

■ PWM Input Signal

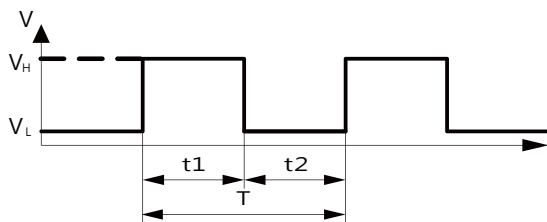
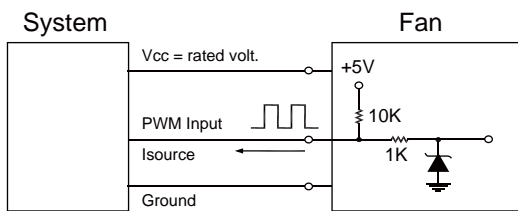

1. Period :  $T = \frac{1}{f_{PWM}} = t1 + t2(\text{sec})$

2. Duty Cycle ( D.C. ) :  $\frac{t1}{t1+t2} * 100 = \frac{t1}{T} * 100(\%)$

VH=2.8~5.5V

VL=0~0.8V

PWM FREQUENCY: 25KHZ

Isource=0.5mA at PWM Input Voltage 0V

The speed is default to be maximum if PWM input pin is unconnected.

Min. start up duty cycle is 10%.

■ PWM Curve

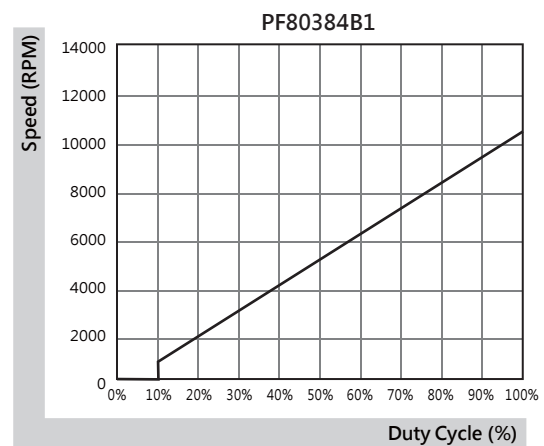
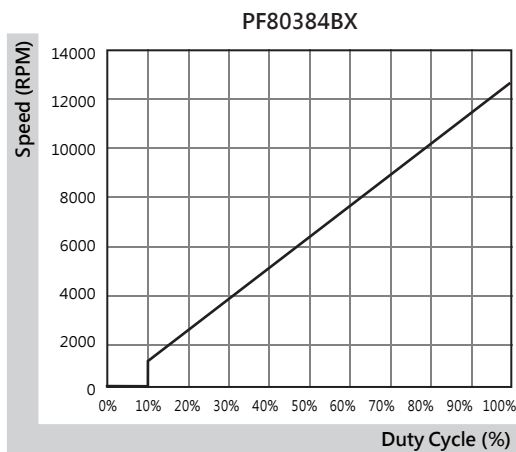

\*All model could be customized. Please contact with Sunon Sales.

\*Specifications are subject to change without notice. Please Visit SUNON website at [www.sunon.com](http://www.sunon.com) for update information.

92x92x38 mm

138.1~182.4 CFM

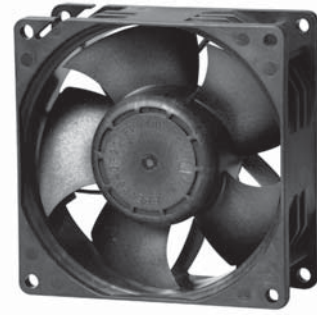

■ Specifications

Model	Bearing	Rating Voltage	Power Current	Power Consumption	Speed	Air Flow	Static Pressure	Noise	Weight	Curve
	2BALL Sleeve	(VDC)	(mA)	(WATTS)	(RPM)	(CFM)	(Inch-H <sub>2</sub> O)	(dB(A))	(g)	
PF92381BX-0000-A99	☉	12	4000	48.00	13000	182.4	2.94	72.1	210.0	1
PF92381B1-0000-A99	☉	12	1700	20.40	9800	138.1	1.95	63.7	210.0	2

■ Function

PF92381BX / 1

A99: AutoRestart

F99: AutoRestart and R type

G99: AutoRestart and F type

H99: AutoRestart and PWM

Q99: AutoRestart , R type and PWM

S99: AutoRestart , F type and PWM

■ Air Flow-Static Pressure Characteristics

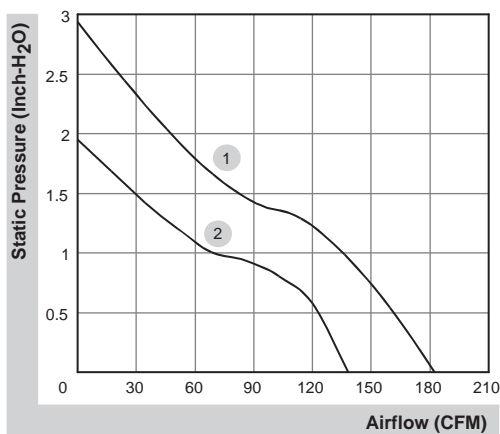

■ External dimensions(mm)

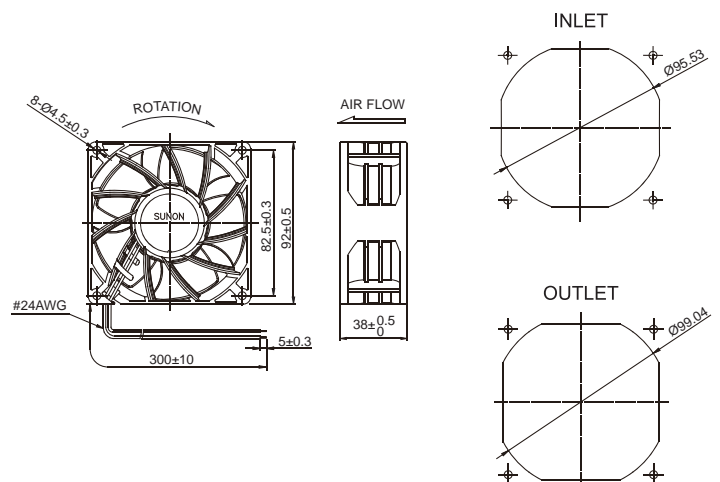

\*All model could be customized. Please contact with Sunon Sales.

\*Specifications are subject to change without notice. Please Visit SUNON website at [www.sunon.com](http://www.sunon.com) for update information.

## ■ FG Signal

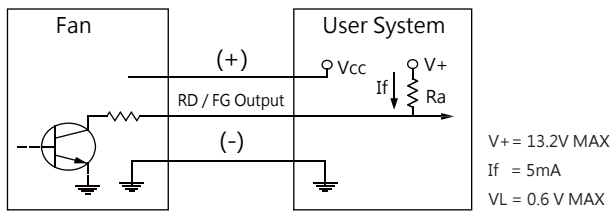

### [ RD Signal ]

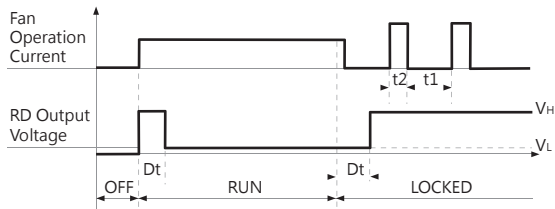

### [ FG Signal ]

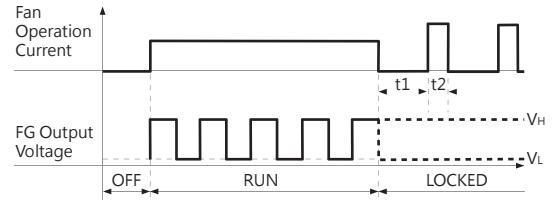
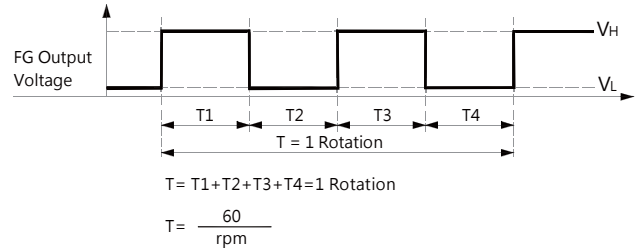

## ■ PWM Input Signal

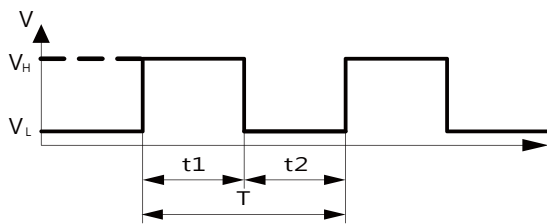
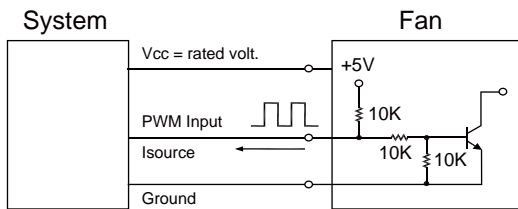

1. Period : 
$$T = \frac{1}{f_{PWM}} = t1 + t2(\text{sec})$$

2. Duty Cycle ( D.C. ) : 
$$\frac{t1}{t1+t2} * 100 = \frac{t1}{T} * 100(\%)$$

VH=2.3~5.5V

VL=0~0.8V

PWM FREQUENCY: 25KHZ

Isource=0.5mA at PWM Input Voltage 0V

The speed is default to be maximum if PWM input pin is unconnected.

Min. start up duty cycle is 10%.

## ■ PWM Curve

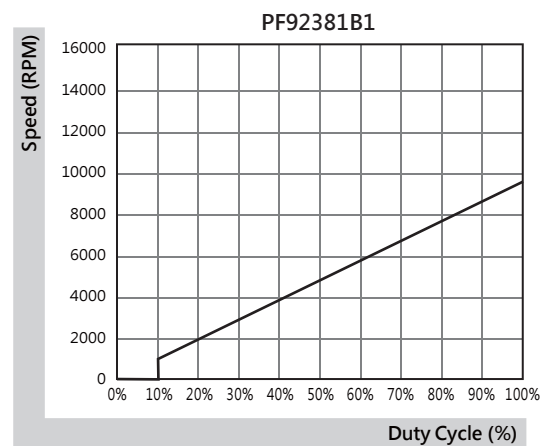
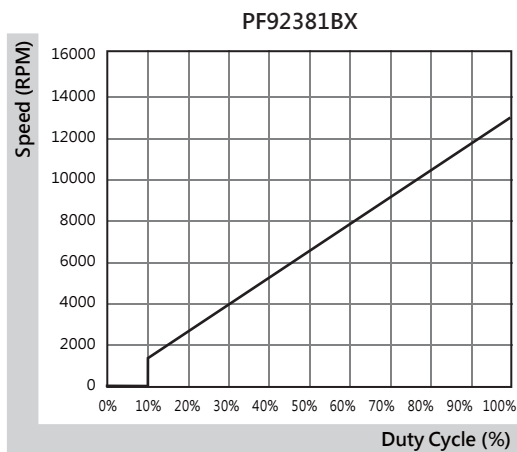

\*All model could be customized. Please contact with Sunon Sales.

\*Specifications are subject to change without notice. Please Visit SUNON website at [www.sunon.com](http://www.sunon.com) for update information.



140x140x38 mm

238.5~297.9 CFM



■ Specifications

Model	Bearing	Rating Voltage	Power Current	Power Consumption	Speed	Air Flow	Static Pressure	Noise	Weight	Curve
	2BALL Sleeve	(VDC)	(mA)	(WATTS)	(RPM)	(CFM)	(Inch-H <sub>2</sub> O)	(dB(A))	(g)	
PFE0381BX-0000-A99	☉	12	3300	39.60	6800	297.9	2.05	68.3	472.0	1
PFE0381B1-0000-A99	☉	12	1720	20.64	5500	238.5	1.20	62.0	472.0	2

■ Function

PFE0381BX / 1

A99: AutoRestart

F99: AutoRestart and R type

G99: AutoRestart and F type

H99: AutoRestart and PWM

Q99: AutoRestart , R type and PWM

S99: AutoRestart , F type and PWM

■ Air Flow-Static Pressure Characteristics

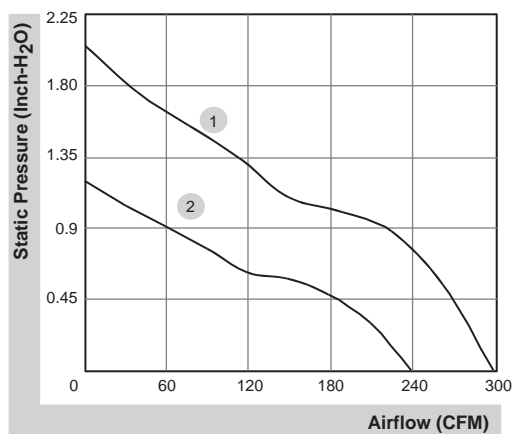

■ External dimensions(mm)

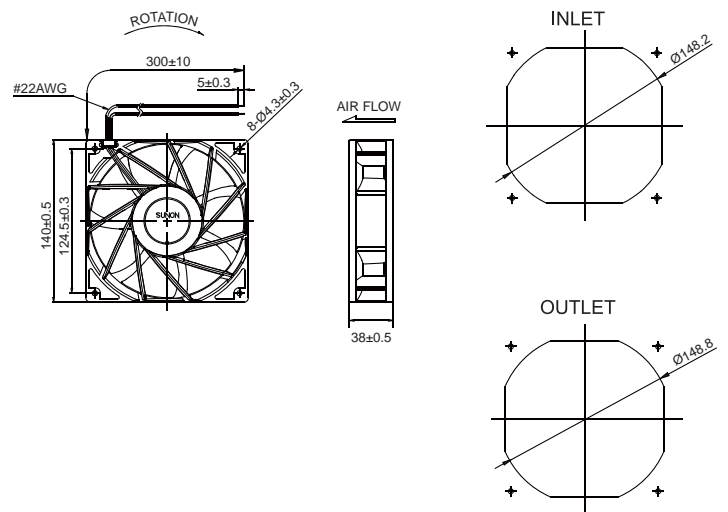

\*All model could be customized. Please contact with Sunon Sales.

\*Specifications are subject to change without notice. Please Visit SUNON website at [www.sunon.com](http://www.sunon.com) for update information.

■ FG Signal

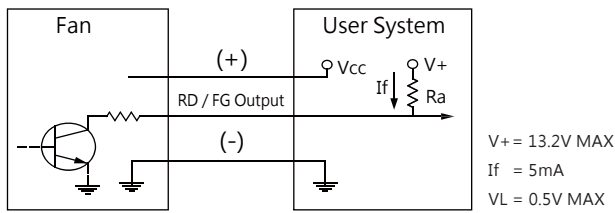

[ FG Signal ]

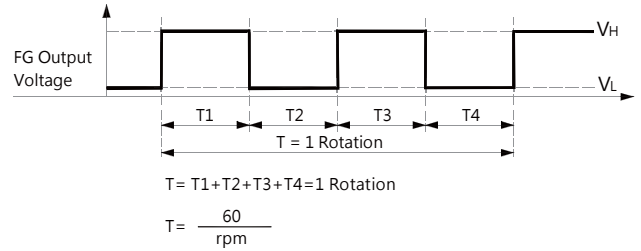

[ RD Signal ]

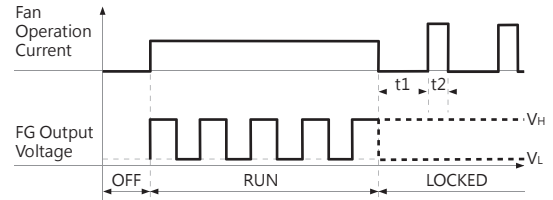
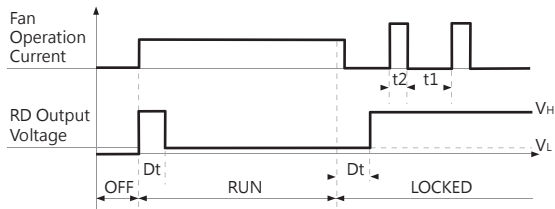

■ PWM Input Signal

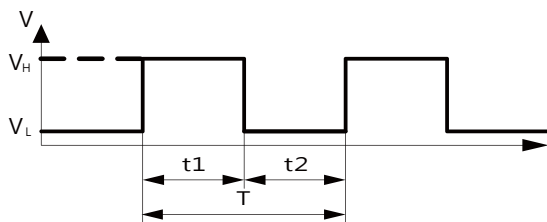
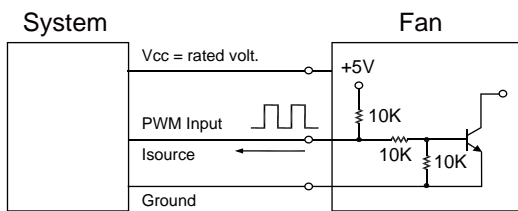

1. Period : 
$$T = \frac{1}{f_{PWM}} = t1 + t2(\text{sec})$$

2. Duty Cycle ( D.C. ) : 
$$\frac{t1}{t1+t2} * 100 = \frac{t1}{T} * 100(\%)$$

VH=2.3~5.5V

VL=0~0.8V

PWM FREQUENCY: 25KHZ

Isource=0.5mA at PWM Input Voltage 0V

The speed is default to be maximum if PWM input pin is unconnected.

Min. start up duty cycle is 10%.

■ PWM Curve

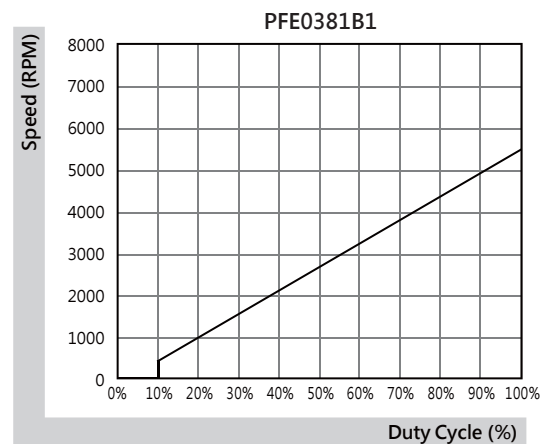
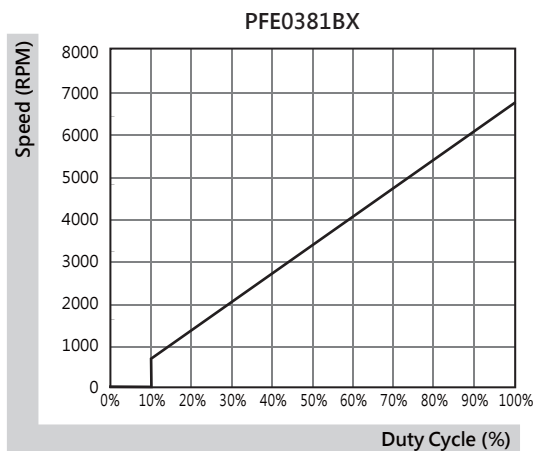

\*All model could be customized. Please contact with Sunon Sales.

\*Specifications are subject to change without notice. Please Visit SUNON website at [www.sunon.com](http://www.sunon.com) for update information.

140x140x38 mm

282.6 CFM



■ Specifications

Model	Bearing	Rating Voltage	Power Current	Power Consumption	Speed	Air Flow	Static Pressure	Noise	Weight	Curve
	2BALL Sleeve	(VDC)	(mA)	(WATTS)	(RPM)	(CFM)	(inch-H <sub>2</sub> O)	(dB(A))	(g)	
PFE0384BX-0000-A99	☉	48	740	35.52	6600	282.6	1.88	65.9	560.0	1

■ Function

PFE0384BX

- A99: AutoRestart
- F99: AutoRestart and R type
- G99: AutoRestart and F type
- H99: AutoRestart and PWM
- Q99: AutoRestart , R type and PWM
- S99: AutoRestart , F type and PWM

■ Air Flow-Static Pressure Characteristics

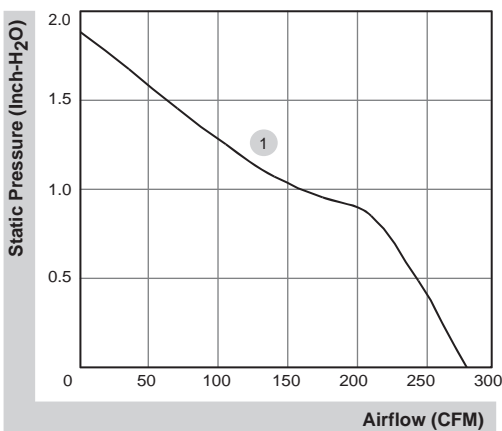

■ External dimensions(mm)

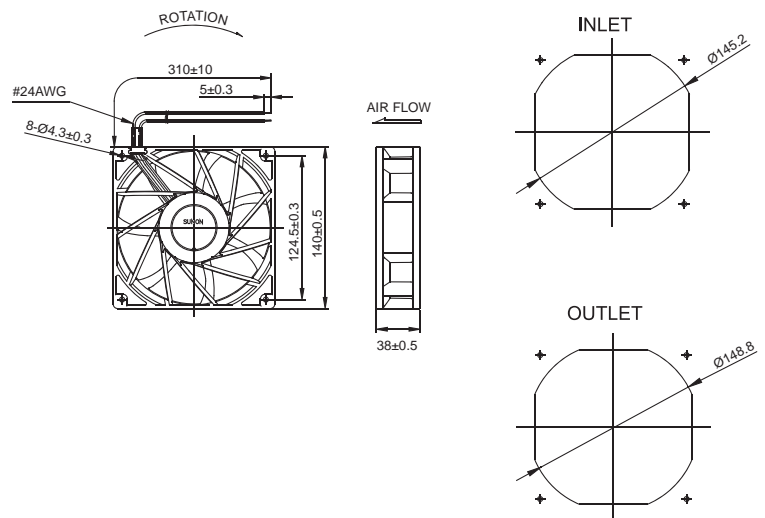

\*All model could be customized. Please contact with Sunon Sales.

\*Specifications are subject to change without notice. Please Visit SUNON website at [www.sunon.com](http://www.sunon.com) for update information.

■ FG Signal

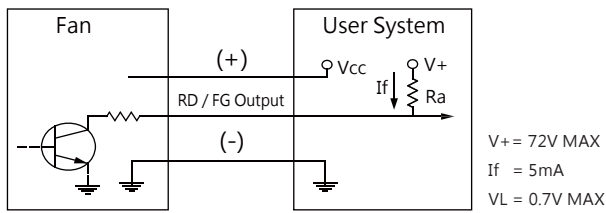

[ FG Signal ]

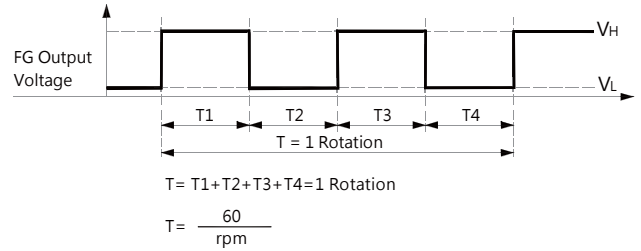

[ RD Signal ]

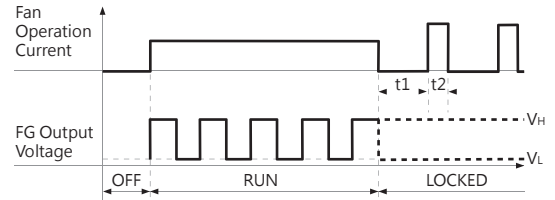
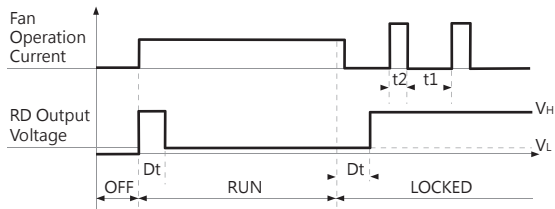

■ PWM Input Signal

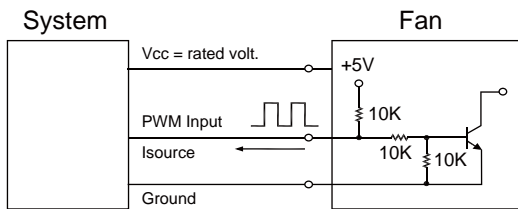

1. Period : 
$$T = \frac{1}{f_{PWM}} = t1 + t2(\text{sec})$$

2. Duty Cycle ( D.C. ) : 
$$\frac{t1}{t1+t2} * 100 = \frac{t1}{T} * 100(\%)$$

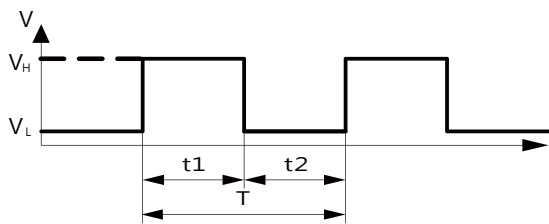

VH=2.3~5.5V

VL=0~0.8V

PWM FREQUENCY: 25KHZ

Isource=0.5mA at PWM Input Voltage 0V

The speed is default to be maximum if PWM input pin is unconnected.

Min. start up duty cycle is 10%.

■ PWM Curve

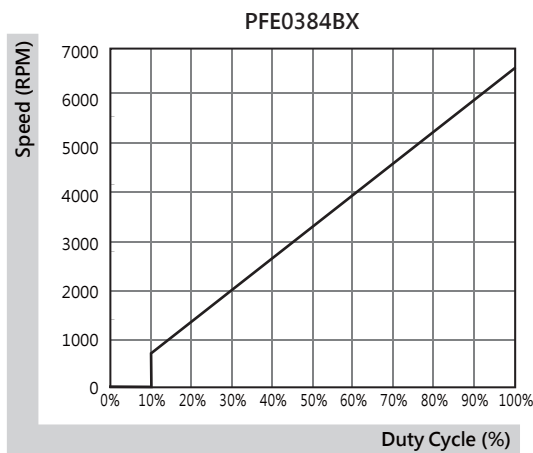

\*All model could be customized. Please contact with Sunon Sales.

\*Specifications are subject to change without notice. Please Visit SUNON website at [www.sunon.com](http://www.sunon.com) for update information.

140x140x51 mm

250.3 CFM



■ Specifications

Model	Bearing	Rating Voltage (VDC)	Power Current (mA)	Power Consumption (WATTS)	Speed (RPM)	Air Flow (CFM)	Static Pressure (inch-H <sub>2</sub> O)	Noise (dB(A))	Weight (g)	Curve
PFE0514B1-0000-A99	2BALL Sleeve	48	470	22.56	5000	250.3	1.43	61.4	635.0	1

■ Function

PFE0514B1

A99: AutoRestart

F99: AutoRestart and R type

G99: AutoRestart and F type

H99: AutoRestart and PWM

Q99: AutoRestart , R type and PWM

S99: AutoRestart , F type and PWM

■ Air Flow-Static Pressure Characteristics

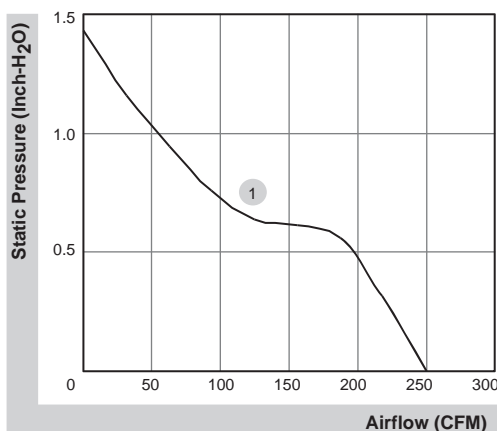

■ External dimensions(mm)

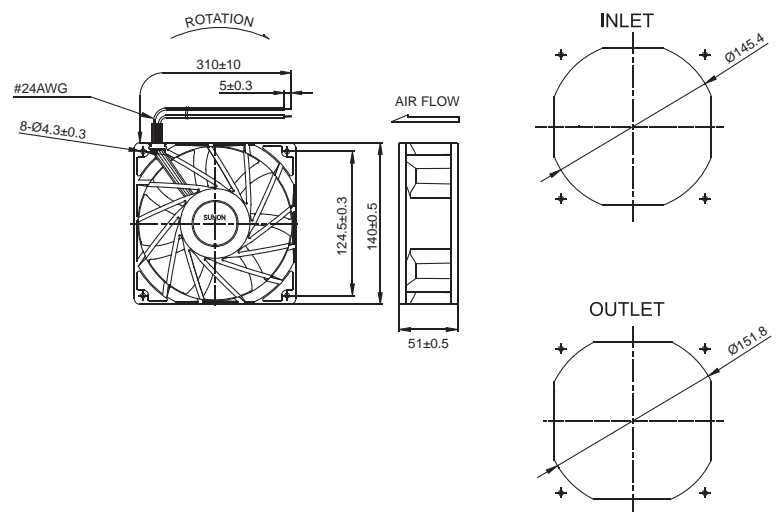

\*All model could be customized. Please contact with Sunon Sales.

\*Specifications are subject to change without notice. Please Visit SUNON website at [www.sunon.com](http://www.sunon.com) for update information.

■ FG Signal

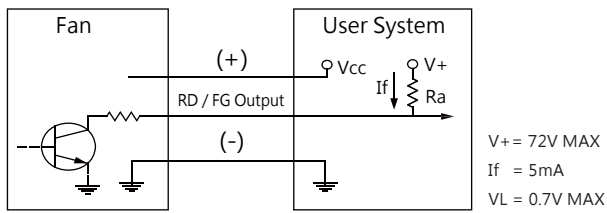

[ FG Signal ]

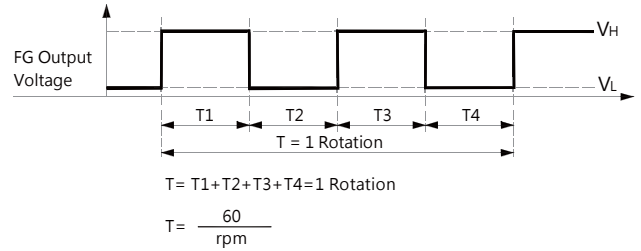

[ RD Signal ]

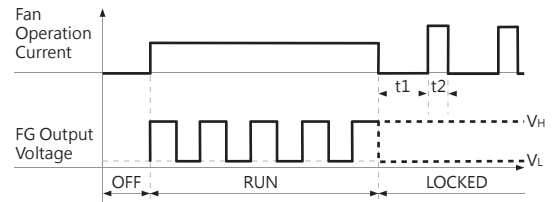
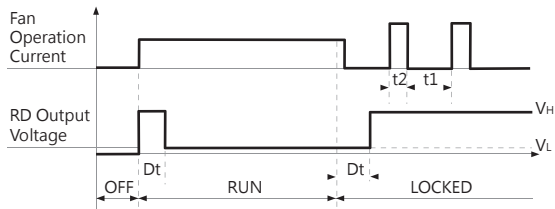

■ PWM Input Signal

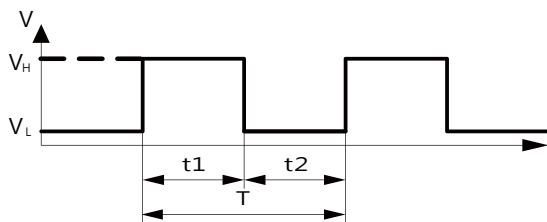
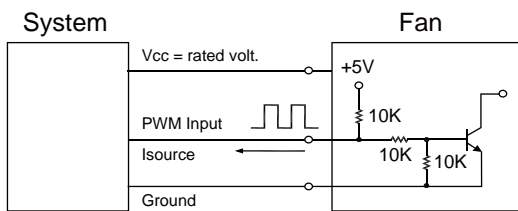

1. Period :  $T = \frac{1}{f_{PWM}} = t1 + t2(\text{sec})$

2. Duty Cycle ( D.C. ) :  $\frac{t1}{t1+t2} * 100 = \frac{t1}{T} * 100(\%)$

VH=2.3~5.5V

VL=0~0.8V

PWM FREQUENCY: 25KHZ

Isource=0.5mA at PWM Input Voltage 0V

The speed is default to be maximum if PWM input pin is unconnected.

Min. start up duty cycle is 10%.

■ PWM Curve

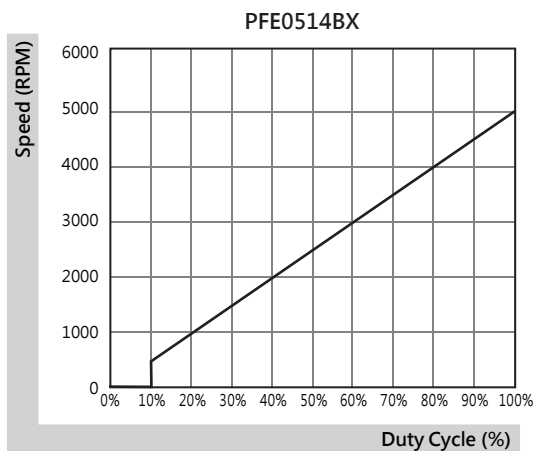

\*All model could be customized. Please contact with Sunon Sales.

\*Specifications are subject to change without notice. Please Visit SUNON website at [www.sunon.com](http://www.sunon.com) for update information.

97x95x33 mm

44.2~54.7 CFM



■ Specifications

Model	Bearing	Rating Voltage	Power Current	Power Consumption	Speed	Air Flow	Static Pressure	Noise	Weight	Curve
	2BALL Sleeve	(VDC)	(mA)	(WATTS)	(RPM)	(CFM)	(Inch-H <sub>2</sub> O)	(dB(A))	(g)	
PF97331BX-B000-A99	☉	12	3500	42.00	6800	54.7	5.22	63.2	184.0	1
PF97331B1-B000-A99	☉	12	1600	19.20	5400	44.2	3.39	58.0	184.0	2

■ Function

PF97331BX / 1

A99: AutoRestart

F99: AutoRestart and R type

G99: AutoRestart and F type

H99: AutoRestart and PWM

Q99: AutoRestart , R type and PWM

S99: AutoRestart , F type and PWM

■ Air Flow-Static Pressure Characteristics

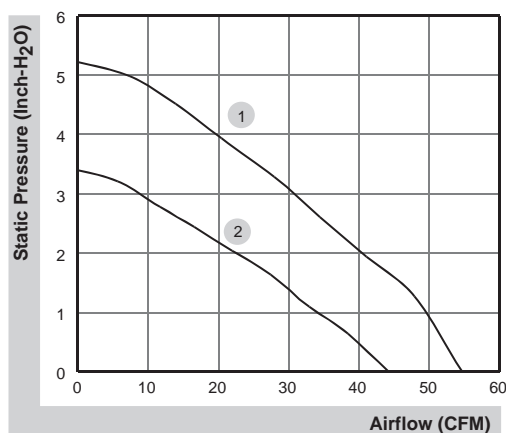

■ External dimensions(mm)

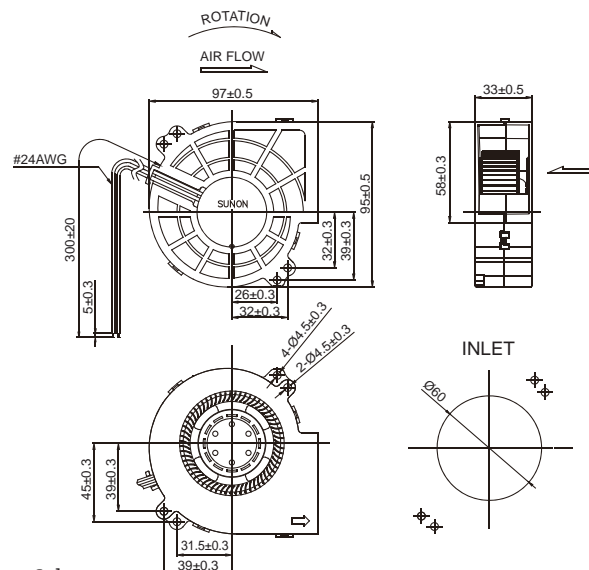

\*All model could be customized. Please contact with Sunon Sales.

\*Specifications are subject to change without notice. Please Visit SUNON website at [www.sunon.com](http://www.sunon.com) for update information.

2013/09/30 (198-A)

■ FG Signal

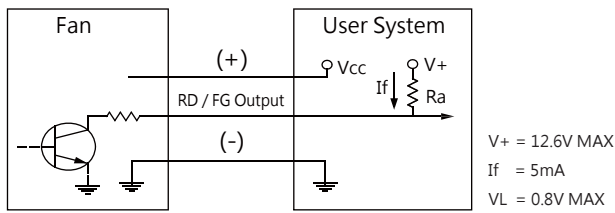

[ RD Signal ]

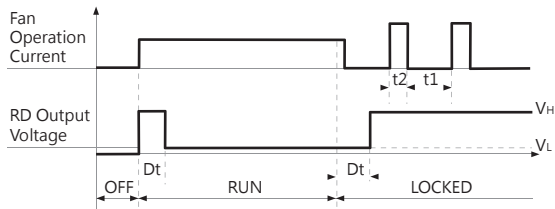

[ FG Signal ]

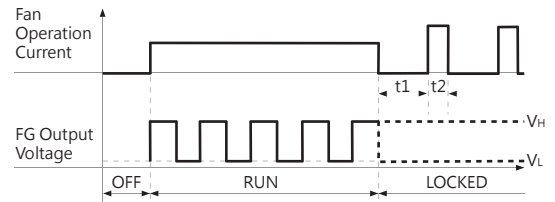
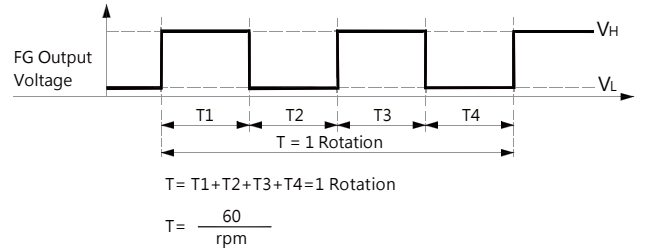

■ PWM Input Signal

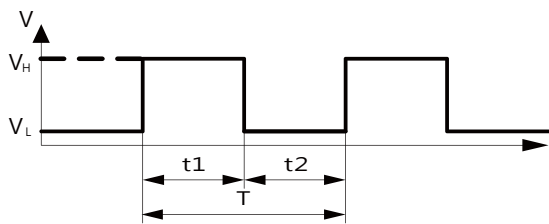
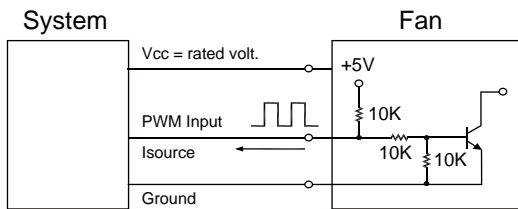

1. Period :  $T = \frac{1}{f_{\text{PWM}}} = t_1 + t_2(\text{sec})$

2. Duty Cycle ( D.C. ) :  $\frac{t_1}{t_1 + t_2} * 100 = \frac{t_1}{T} * 100(\%)$

VH=2.3~5.5V

VL=0~0.8V

PWM FREQUENCY: 25KHZ

Isource=0.5mA at PWM Input Voltage 0V

The speed is default to be maximum if PWM input pin is unconnected.

Min. start up duty cycle is 10%.

■ PWM Curve

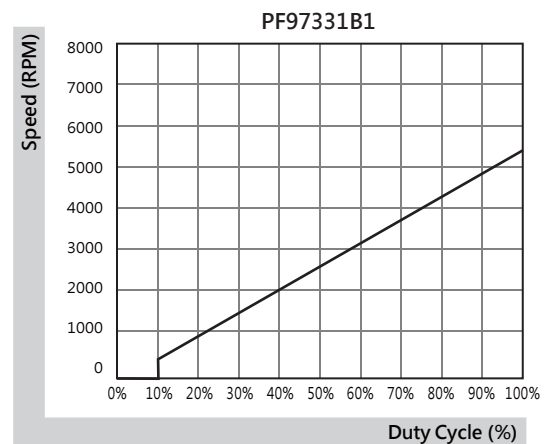
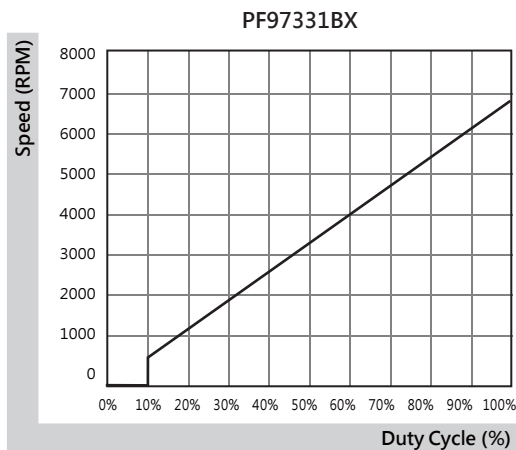

\*All model could be customized. Please contact with Sunon Sales.

\*Specifications are subject to change without notice. Please Visit SUNON website at [www.sunon.com](http://www.sunon.com) for update information.



**SUNON®**

**вентиляторы SUNON для серверов, хранилищ информации, телекоммуникаций,  
шкафов**

**продажа в Минске**

**тел.моб. 8(044)7584780 VEL**

**8(029)7584780 мтс Минск тел.факс 8(017)2005646**

**ВЕНТИЛЯТОР SUNON DC продажа в Минске [www.fotorele.net](http://www.fotorele.net) [www.tiristor.by](http://www.tiristor.by)**

**email [minsk17@tut.by](mailto:minsk17@tut.by)**